

ONE

User Manual



► CONTENTS

CONTENTS	2
MANUAL REVISIONS	5
NOTIFICATIONS	6
· Explanation of descriptions	6
GENERAL	7
· Introduction	7
· General instructions	7
· Warnings & Precautions	8
· Warnings & Precautions (continued)	9
· Warnings & Precautions (continued)	10
· Precautions	10
· Intended use	11
· Packaging	11
· Delivery inspection	12
· Long-term storage requirements	12
· Machine disposal requirements	13
· Caution	13
TECHNICAL SPECIFICATIONS	14
· Machine data	14
· Accessories	14
· Machine description	15
· External dimensions	15
BUTTONS AND CONTROLS	16
· 1B Version	16
· 2B versions	16
INSTALLATION AND START UP	17
· Machine positioning	17
· Hydraulic supply types	17
· Filling the water tank	18
· Mains water connection	18
· Water filter requirements	19
· Boiler pressure and temperature information	19
· Drain connection checklist	20
· Electrical connection checklist	20

► CONTENTS

· Electrical connection checklist (continued)	21
· Initial starting procedure	21
· Machine handling tips	21
OPERATION	22
· Inserting the portafilter in the group	22
· Espresso brewing	22
· Steaming and frothing milk	23
· Dispensing hot water	23
CLEANING AND CARE	24
· Cleaning reminders	24
· Daily cleaning – At the end of each working day be sure to:	24
· Daily flushing	24
· Weekly cleaning or Periodical cleaning and care – Once per week be sure to:	25
· Weekly cleaning with espresso machine detergent	25
USER PROGRAMMING 1B	26
· User interface 1B	26
· Adjusting boiler temperature	26
USER PROGRAMMING 2B	27
· User Interface 2B	27
· Barista menu - Access & browsing	27
· Gradual soft preinfusion (GSP) menu (Rotary pump versions only)	27
· Temperature adjustment	28
· ECO mode	28
· Heating element On/Off	28
· Clock menu	29
· Auto On/Off menu	29
· Shot screen adjustment	29
· Counters menu	30
· Temperature units	30
· Date format	30
· USB communication (LFPP version only)	31
· Barista knob resolution (LFPP version only)	31
PRESSURE PROFILING MENU	32
· Manual mode: Access	32
· Manual mode: Initial PP pressure	32

► CONTENTS

· Manual mode: Run the shot	32
· Manual mode: Save recipe	32
· Recipe mode: Choose recipe	33
· Recipe mode: Recipe graph information	33
· Recipe mode: Run the shot	33
MACHINE ALERTS	34
· Alarms & Warnings	34
TROUBLESHOOTING	35
· Machine faults	35
· Brewing faults	35
· Limescale faults	35

Thank you for choosing the ONE espresso machine. We hope you enjoy it!

▶ MANUAL REVISIONS

Rev. #	Date	TSB#	Description
01	July 25, 2019	none	Release first draft for technical review.
02	Oct. 28, 2019	none	Add programming information.
03	Nov. 12, 2019	none	Add compliance and certification notes.
04	Nov. 14, 2019	none	Combine EU and US version information into single user manual.
05	Apr. 03, 2020	#257	Software update. 1B (1.05) / 2B (1.09)
06	Apr. 27, 2020	none	Filter installation instructions added
07			

► NOTIFICATIONS

· Explanation of descriptions

There are five different levels of notification intensity within this manual, as identified by the signal words DANGER, WARNING, IMPORTANT, NOTE and PRO TIP. The level of risk and importance of the notification is determined by the following definitions. Always observe the warnings to ensure safety and prevent potential injury and product damage.

**Important:**

Alerts against unsafe practices. Observe Important notifications to ensure food safety, prevent possible minor personal injury, or damage to the machine.

**WARNING:**

Indicates a potentially hazardous situation which, if the WARNING is ignored, could result in serious injury or even death.

**DANGER:**

INDICATES AN IMMINENTLY HAZARDOUS SITUATION WHICH, IF NOT AVOIDED, WILL LIKELY RESULT IN SERIOUS INJURY AND EVEN DEATH.

**Note:**

Gives additional information which may be helpful during the operation, routine maintenance, and cleaning of the machine.

**Pro Tip:**

Gives helpful hints and suggestions from the manufacturer that take the guesswork out of choosing settings and care intervals.

► GENERAL

· Introduction

- Please read this user manual carefully before using the machine.
- This manual contains important instructions regarding safe intended use of the machine.
- Do not discard this manual, it will be useful for future reference. If damaged or lost, request a new copy from the manufacturer/distributor.

· General instructions

- Machine installation and certain maintenance operations should only be performed by qualified service personnel.
- All safety instructions and warnings contained in this manual should be observed at all times to ensure safe installation, use, and maintenance.
- Do not attempt to remove covers or safety shields to access the interior of this machine or make repairs. Repairs should be made by an authorised technician or service centre.
- Owners are liable for ensuring that users have been properly trained to operate the machine and understand the potential risks involved.
- The owner or installer will be liable for all non-authorised modification of the machine.
- Non-authorised alteration or modification of the machine will immediately void the manufacturer's warranty.
- This manual references the machine at the time of sale. The commercial availability of subsequent versions including modifications, upgrades or adaptations does not oblige the manufacturer to apply any changes to this machine, nor is it obliged to update the documentation supplied.
- The manufacturer reserves the right to withdraw currently available manuals whenever deemed appropriate and reasonable.
- Periodically, some updates and changes may be required for this machine. In this event, a technician will be responsible for ensuring the change is made in accord with manufacturer's specifications.

► GENERAL

· Warnings & Precautions

Note: The manufacturer is not liable for damage to persons or property resulting from failure to follow the instructions and warnings listed below when installing and using this machine.

- Install the machine in a horizontal position and away from heat sources and flammable objects.
- Appliance is only to be installed in locations where its use and maintenance is restricted to trained personnel. Access to the service area is restricted to persons having knowledge and practical experience of the appliance, in particular as far as safety and hygiene are concerned.
- This machine should only be installed on a water-resistant work surface that is capable of adequately supporting the machine's weight.
- The appliance is not suitable for installation in an area where a water jet could be used. This appliance must not be cleaned with a water jet or a pressure washer.
- The appliance is not suitable for outdoor use, where it would be exposed to severe weather or extreme temperatures.
- The instructions for appliances connected to the water mains by detachable hose-sets shall state that the new hose-sets supplied with the appliance are to be used and that old hose-sets should not be reused.
- Use the inlet hose included with the machine to connect it to the water mains in accordance with the national rules applicable in the country where machine is installed.
- Plug the machine into a properly installed, earth grounded electrical outlet with line voltage that matches the specifications for the machine.
- For appliances not fitted with a supply cord and a plug, means for disconnection must be incorporated in the fixed wiring in accordance with the wiring rules.
- Ensure that the power supply voltage does not fluctuate by more than 6%.
- Position the power cable so that users cannot trip over it. Keep the power cable away from sharp edges and heat sources.
- Do not remove or disable any of the mechanical, electrical, or thermal protection safety equipment.
- If supply cord is damaged, it must be replaced by the manufacturer, its service agent or similarly qualified persons in order to avoid a hazard.

► GENERAL

· Warnings & Precautions (continued)

- In case of emergency, (e.g., the machine catches fire or becomes unusually hot or noisy), disconnect the power immediately and turn off the water supply.
 - If the machine is not going to be used for an extended period of time, disconnect the power. When disconnecting the power, pull the plug rather than the cable.
 - Keep all hazardous packaging materials, such as plastic bags, styrofoam, and staples, out of reach of children.
 - Before performing maintenance and/or moving the machine, disconnect the machine from the power supply and wait for it to cool down.
 - To ensure fault-free machine operation, only use manufacturer-approved replacement parts and accessories.
 - When packed for storage, store the machine in a dry place with an ambient temperature above 5°C. Boxes may be stacked up to three units high of the same model. Do not place other heavy items on top of the box.
 - If the machine is likely to be exposed to temperatures below 0°C during handling and transport, make sure that service personnel empty the boiler and water system.
- (The machine's boiler and water system are empty when delivered from the factory.)
- Never immerse the machine, plug or power cable in water, as there is a risk of electric shock.
 - Place the machine out of reach of children.
 - This appliance is not intended for use by persons (including children) with reduced physical, sensory or mental capabilities, or lack of experience and knowledge, unless they have been given supervision or instruction concerning use of the appliance by a person responsible for their safety.
- Note: safety regulation not valid for Europe.**
- **Specific safety regulation for Europe:** This appliance can be used by children aged from 8 years and above and persons with reduced physical, sensory or mental capabilities or lack of experience and knowledge if they have been given supervision or instruction concerning use of the appliance in a safe way and understand the hazards involved. Children shall not play with the appliance. Cleaning and user maintenance shall not be made by children without supervision.

► GENERAL

· Warnings & Precautions (continued)

- Do not use the machine if the power cable or plug is damaged, or the machine has been dropped. Contact a service technician for repairs or to ensure that it is safe for use.
- Do not place any liquids on the machine.
- Do not touch the machine's hot surfaces or dispensing equipment.
- Do not touch the machine if your hands or feet are wet.
- Do not operate the machine if any part except the dispensing equipment is wet.
- Do not block the vents with rags or other objects.
- Do not insert foreign objects into the vents.
- Check the drain regularly to make sure that waste water is emptying properly.

· Precautions

- Before performing maintenance and/or moving the machine, disconnect the machine from the power supply and wait for it to cool down.
- Do not place any liquids on the machine.
- This appliance must not be cleaned with a pressure washer.
- Never immerse the machine, plug or power cable in water, as there is a risk of electric shock.
- Do not touch the machine's hot surfaces or dispensing equipment.
- Do not touch the machine if your hands or feet are wet.
- Do not operate the machine if any part except the dispensing equipment is wet.
- Place the machine out of reach of children.
- This appliance can be used by children from age 8 and above and persons with reduced physical, sensory, or mental capabilities or lack of experience and knowledge if they have been given supervision or instruction concerning use of the appliance in a safe way and understand the hazards involved.
- Children shall not play with the appliance.
- Cleaning and user maintenance shall not be made by children without supervision.
- Do not use the machine if the power cable or plug is damaged, or the machine has been dropped. Contact a service technician for repairs or to ensure that it is safe for use.
- Do not block the vents with rags or other objects.
- Do not insert foreign objects into the vents.
- Check the drain regularly to make sure that waste water is emptying properly.
- Children should be supervised to ensure that they do not play with the appliance.

► GENERAL

· Intended use

- To ensure optimal performance, install the machine in a location where these parameters will not be exceeded:
 - Maximum permissible inlet water pressure: 600 KPa (6 Bar) / 87 psi.
 - Minimum permissible inlet water pressure: 200 KPa (2 Bar) / 29 psi
 - Maximum inlet water temperature: 40°C / 104°F
 - Ambient temperature is between +10°C / 50°F (min.) and +40°C / 104°F (max.).
- The machine is intended to be used by trained personnel for preparing foodstuffs.
- The coffee machine has been designed and manufactured to make espresso coffee and other hot drinks (e.g., steaming and frothing milk). Do not use it for any other purpose.
- The A-weighted sound pressure level is below 70 dB.
- This machine is not intended for use in industrial kitchens, domestic kitchens, or similar locations.
- The manufacturer will not be held liable for damage to persons or property due to incorrect, improper or negligent use by nonprofessional personnel.

· Packaging

- The machine is shipped in a custom-designed carton which utilizes model-specific polystyrene cushions to protect it from damage.
- The machine's carton features standardized handling symbols to explain proper shipping and storage methods.
- The machine must remain in a horizontal position during the transport. Do not store or handle the machine except on its feet.
- During transport protect the carton and machine from impact drops, crushing, shocks, moisture and exposure to extreme temperature.

► GENERAL

· Delivery inspection

- Upon receipt and delivery ensure that the machine is in the exact condition described in the enclosed documentation, and that all accessories are included. Missing items should be reported to the manufacturer or dealer immediately.
- Damage caused during transport should be reported to the shipping agent and the machine's distributor immediately.
- Packaging materials are potentially dangerous and should be kept away from children.
- The carton and all packing materials are recyclable and should be returned to a recycling center for disposal.

· Long-term storage requirements

- Before storage or a month or more be sure to:
 - Perform all weekly and periodic cleaning procedures described in this manual.
 - Disconnect and roll up the power cord (this should be performed by a qualified person).
 - Disconnect the machine's water inlet hose from the domestic water supply and drain the boilers (this should be performed by a qualified person).
 - Clean the drip tray and exterior of the machine to remove any coffee or other residue.
 - Cover / re-pack the machine in its original carton and store it in a dry place where it will not be exposed to extreme temperatures or humidity.
 - When returning the machine to service after long-term storage, perform all weekly and periodic cleaning procedures and reconnect the water and power supplies (this should be performed by a qualified person) before use.

► GENERAL

· Machine disposal requirements

- If the machine ever needs to be scrapped and disposed of be sure to:

- Disconnect and roll up the power cord (this should be performed by a qualified person).
- Disconnect the machine's water inlet hose from the domestic water supply and drain the boilers (this should be performed by a qualified person).
- Pack up and ship/deliver the machine to a certified recycling center.



· Caution

- Risk of fire and electric shock.
- Replace only with manufacturer's original cord set.
- Disconnect from power supply before servicing.





















► TECHNICAL SPECIFICATIONS

· Machine data

	ONE 1B VP	ONE 2B VP	ONE 2B RP-GSP	ONE 2B RP-LFPP
EU Compliance codes:	EAEB-I91F-13AP	EEEE-I91F-13AP	EEEE-I91G-13AP	EEEE-I94G-13AP
US Compliance codes:	EAJB-K91F-13BP	EEJB-K91F-13BP	EEJB-K91G-13BP	EEJB-K94G-13BP
Temperature control:	PID control	PID control	PID control	PID control
Dispensing control system:	Manual Group lever	Manual Group lever	Manual Group lever + GSP	Manual Group lever + GSP + LFPP
Steam wand:	1 unit	1 unit	1 unit	1 unit
Hot water outlet:	1 unit	1 unit	1 unit	1 unit
Boiler system:	1 steam boiler	Dual boiler: 1 steam boiler + 1 group boiler	Dual boiler: 1 steam boiler + 1 group boiler	Dual boiler: 1 steam boiler + 1 group boiler
Boiler operating pressure:	0.8 to 1.2 bar / 12-17 psi	0.8 to 1.2 bar / 12-17 psi	0.8 to 1.2 bar / 12-17 psi	0.8 to 1.2 bar / 12-17 psi
Steam boiler volume:	1.7L / 0.45 gal.	1.7L / 0.45 gal.	1.7L / 0.45 gal.	1.7L / 0.45 gal.
Group boiler volume:	N/A	1.5L / 0.40 gal.	1.5L / 0.40 gal.	1.5L / 0.40 gal.
220-240V Power rating:	220-240V~ 50- 60Hz 1800W	220-240V~ 50- 60Hz 1800W	220-240V~ 50- 60Hz 1800W	220-240V~ 50- 60Hz 1800W
110-127V Power rating:	110-127V~ 50- 60Hz 1300W	110-127V~ 50- 60Hz 1300W	110-127V~ 50- 60Hz 1300W	110-127V~ 50- 60Hz 1300W
Water connection:	3/8" Internal thread	3/8" Internal thread	3/8" Internal thread	3/8" Internal thread
Height, width, depth:	420, 300, 458mm / 17, 12, 18in.	420, 300, 458mm / 17, 12, 18in.	420, 300, 458mm / 17, 12, 18in.	420, 311, 458mm / 17, 12, 18in.
Machine weight:	30kg / 66 lb	35kg / 77 lb	35kg / 77 lb	35kg / 77 lb
Ambient noise:	< 70 db	< 70 db	< 70 db	< 70 db

· Accessories

	2-spouts porta filter	Filter basket	Filter blind	Brush	Cleaning tablets	Water tank filter			
For 1B versions		 7 gr.  14 gr.							
Units	1 unit	1 of each	1 unit	1 unit	1 unit	1 unit			
	2-spouts porta filter	Filter basket	Filter blind	Tamper	Extra steam nozzle	Brush	Milk Jar	Cleaning tablets	Water tank filter
For 2B versions		 7 gr.  14 gr.  18 gr.							
Units	1 unit	1 of each	1 unit	1 unit	1 unit	1 unit	1 unit	1 unit	1 unit

► TECHNICAL SPECIFICATIONS

· Machine description

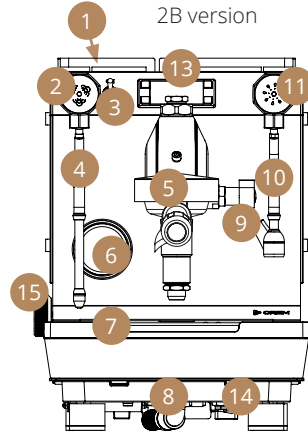
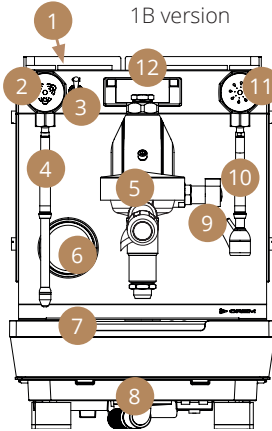

- | | | |
|--------------------------|----------------------------------|---|
| 1. Water tank lid | 8. Drain connection | 13. OLED display (2B versions) |
| 2. Steam knob | 9. Brewing lever | 14. Water connection selector |
| 3. Power switch | 10. Hot water tap | 15. Pressure profiling knob (2B PID R-LFPP) |
| 4. Steam wand | 11. Hot water knob | |
| 5. Brewing group | 12. Digital display (1B version) | |
| 6. Double pressure gauge | | |
| 7. Drip tray | | |

· External dimensions

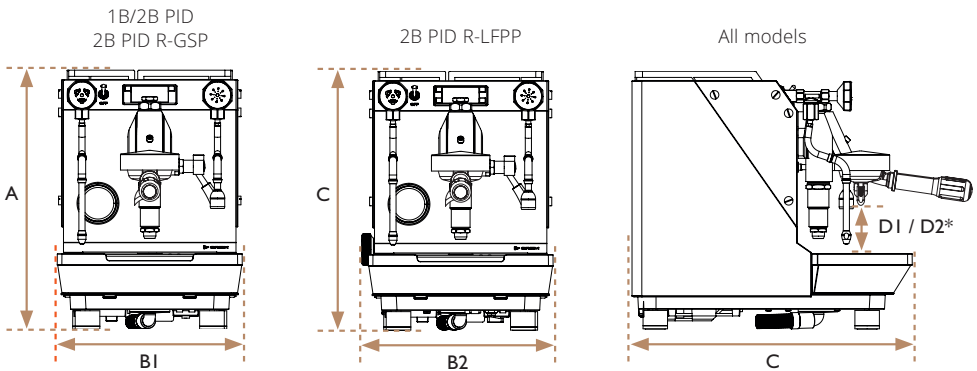

Dimensions	A	B1 / B2	C	D1 / D2
Length	420mm / 17in.	300mm / 311mm 12in. / 12in.	458mm / 18in.	88mm / 102mm 3in. / 4in.

* Measurement without the middle grid.

► BUTTONS AND CONTROLS

· 1B Version

ONE 1B Dual is controlled by a combination of manual control knobs, buttons and a brewing lever for dispensing.

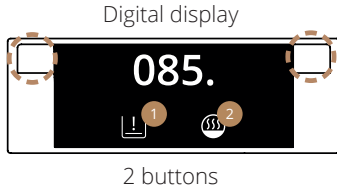

This machine features a group display for monitoring off:

- Shot timer
- 1. Tank empty/refill signal
- Temperature
- 2. Heating signal

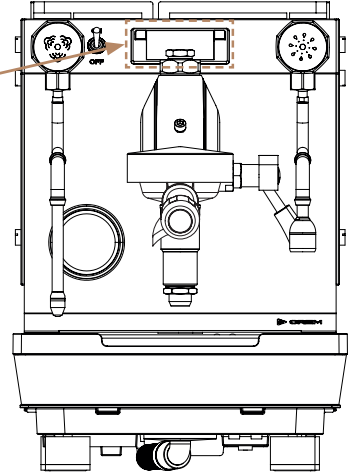

· 2B versions

All ONE 2B versions is controlled by a combination of manual control knobs, buttons and a brewing lever for dispensing. 2B LFPP is also equipped with a pressure profiling knob.

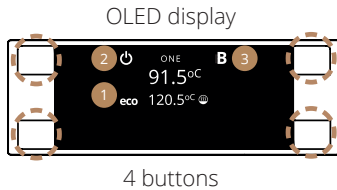

This machine features a OLED display for monitoring off:

- Shot timer
- Temperature
- Volume (2B LFPP)
- Heating
- Tank empty/refill
- Several alarms
- 1. Eco / 2. Standby mode
- 3. Barista menu (Advanced settings)

Pressure profiling knob
(Only 2B LFPP)

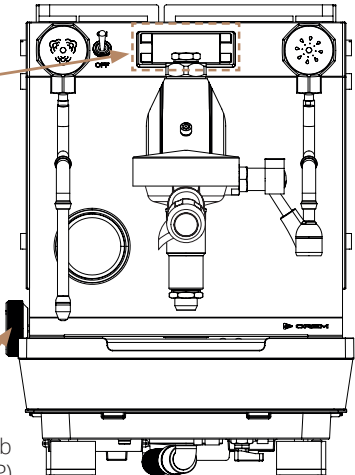

► INSTALLATION AND START UP

· Machine positioning

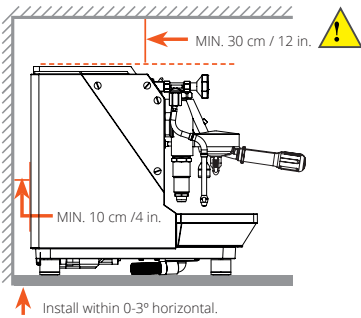

Important:

Leave an air gap of at least 30cm / 12in. above the machine and 10cm / 4in. behind it to ensure easy cleaning and maintenance and adequate ventilation. The machine must be installed within 3° of horizontally level front-to-back and side-to-side to ensure proper hydraulic function and drainage. Confirm with a spirit level or digital angle gauge.

Do not install the machine if the machine or installation surface it is wet. Allow it to dry completely and ask a service technician to ensure that none of the electrical components have been affected.

1. Installing the machine in the service area must be performed by a qualified person. As the machine may be quite heavy, at least two strong, capable individuals are recommend to work together to lift and position the machine. Consult the Technical Specifications page for the specific machine model being installed for machine weight and dimensions details. Contact a service technician to do this task if you are not confident about performing the steps below.
2. Position the machine on a level, sturdy, and water-resistant surface approximately 110cm / 43in. above floor level for ease of access and usage.
3. Adjust the feet to ensure that it dispenses coffee evenly to all cups.

· Hydraulic supply types

This machine is offered with two options for hydraulic connection. Check the machine ratings plate to confirm which arrangement the specific machine is equipped as.

Dual option (WTN):

- The machine is equipped with a water tank and a water mains connection.
- The water tank can be filled manually or, if the machine is plumbed to the mains, the water tank will be refilled automatically when needed without any extra requirements.

Tank + Mains option (WTON):

- The machine is equipped with a water tank and a water mains connection.
- This version has a manual selector located at the bottom of the machine which allows the machine to be refilled automatically from the water mains, or by manually refilling of the water tank, depending on which mode is selected via the valve position as shown in the diagram below.



► INSTALLATION AND START UP

· Filling the water tank



DANGER:

Avoid spills inside the machine, always turn the machine off when refilling the tank. If spills occur, turn the machine off and unplug the power supply until the machine is completely dry to avoid RISK OF SHOCKS.



Note:

For water quality specs, please refer to 'Water filtration requirements'



Note:

The machine has a capacitive sensor that detects when the tank is empty. Therefore, the water tank should only be removed and refilled when espresso is not being brewed.



Note:

The machine has a position switch that blocks all functions if the tank is out of position.

Option 1:

- Remove the top panel/cup warming tray.
- Remove the water tank.
- Fill the tank with clean, fresh drinking water (max. volume = 1.8L / 0.48 gal.).
- Replace the water tank in the machine.
- Replace the top panel/cup warming tray.
- When the boiler is filled and heated, the machine is ready for use.

Option 2:

- Remove the top panel/cup warming tray.
- Using a pitcher, carefully fill the tank with clean, fresh drinking water (max. volume = 1.8L / 0.48 gal.). Avoid spills inside the machine.
- Replace the top panel/cup warming tray.
- When the boiler is filled and heated, the machine is ready for use.

· Mains water connection

1. Connecting the machine to the domestic water supply must be performed by a qualified person. Contact a service technician to do this task you are not confident about performing the steps below.
2. Attach the included 3/8' water inlet hose to the back of the machine (elbow end to machine, straight end to mains) and torque both fittings with a wrench.
3. Purge at least 20 liters of water from the domestic water supply before connecting the machine to it to flush out any debris that may be in the plumbing system that would otherwise accumulate inside the boilers.
4. The domestic plumbing system should be fitted with a brass 3/8" BSPP male pipe fitting and an in-line shut-off valve. Connect the 180cm water inlet hose included with the machine to the domestic water supply and tighten the line fittings with a wrench to 15 ft. lbs. / 20N-m.



Important:

Use the inlet hose included with the machine to connect it to the water mains in accordance with the national rules applicable in the country where machine is installed. Never reuse damaged hoses



Important:

To prevent limescale build up in the boiler and other components, a water-softening system must be installed in-line ahead of the machine. Read more on section for water filter requirements.

For machines with water tank + water mains connection options, please follow the instructions below to connect the machine to the water mains.

- On machines with Tank + Mains option, select 'TAP' on the supply selection tap placed at the bottom of the machine.
- On machines with Dual option, the tank will be refilled automatically.

► INSTALLATION AND START UP

· Water filter requirements

Only use safe drinking water with a hardness rating between 5°fH and 8°fH (French hardness degrees). If the hardness value is below this limit, corrosion of hydraulic components is likely. If the value is higher, lime-scaling inside the boiler will occur. In both cases, the proper function of the machine and quality and taste of the coffee will be negatively affected.

If drinking water is not within the ratings shown above, a water filter must be installed inline ahead of the espresso machine. Failure to install a water filter will result in voiding of the warranty and any damage resulting from limescale buildup will be the responsibility of the owner.

Internal filtration device (Water tank supply)

A filtration device is provided with the accessories of the machine to be installed inside the tank.

For 1st use:

- Take the reservoir out of the machine. Fill it with cold water and immerse the filter for 2 min. to ensure that no air is trapped inside.
- Empty the tank and fit the filter inside the reservoir bottom valve. Push down to lock into place.
- Fill the reservoir again with cold water before placing it in position inside the machine.
- Set the reminder on top of the filter for replacement. Recommended each 2 months.



Important:

Reservoir with filter must be fed only with unsoftened cold potable water. Water of unsafe or unknown microbiological quality may not be used.

Filter.

Part no:
6163022

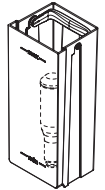

External filtration device (Water mains supply)

1. Ensure that a water filtration device or system is installed in-line in the domestic water supply ahead the machine to prevent contamination inside the machine's hydraulic system. Contact a service technician to do this task if you are not confident about performing the steps below.
2. Open the water tap and allow the filter to fill (if new/previously unused). Then the machine's steam boiler will begin to fill. Check carefully around the service area for leaks or drips. If leaks/drips are detected turn off the tap immediately and check/tighten any leaking fittings.



Important:

Always maintain the water filtration device or system in accordance with the manufacture's specifications. Failure to routinely maintain the filtration device or system will result in limescale build-up inside the machine's hydraulic system which will eventually result in machine failure. Please read more under the cleaning and care section.

· Boiler pressure and temperature information



Pro Tip:

Significantly exceeding this operating range will result in excessive steam, high energy usage, unexpected emergency machine shutdown due to safety valve activation and possibly premature machine failure. Setting the temperature too low will result in poor coffee extraction, slow group boiler heating, and low/no steam.

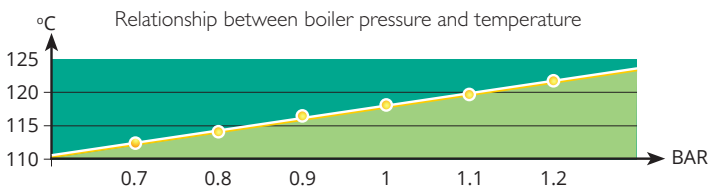

Original instructions.

► INSTALLATION AND START UP

· Drain connection checklist

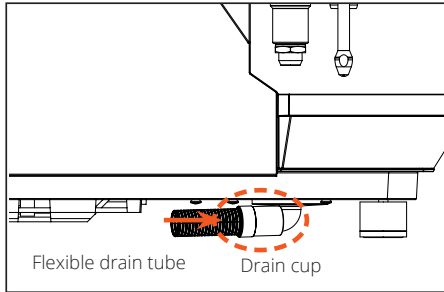

1. Connect one end of the flexible drain tube to the drain cup outlet. (It is located under the machine. Contact a service technician to do this task you are unsure how to access this area of the machine.)
2. Connect the other end of the drain tube to the domestic plumbing drainage system in the service area.
3. Remove the screw of the drain hole at the bottom of the drip tray and replace/reinstall it with the grill.



Pro Tip:

Ensure that the drainage tube is not twisted and that it is below the level of the drain cup to prevent trapping water and other residue in the tube which could mold or produce bad smells. Adjust the height of the machine with the feet if needed.

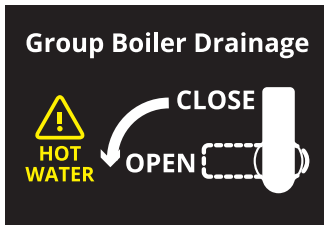

WARNING!

Some models are equipped with boiler drainage. Emptying the boiler must be performed by qualified personnel.

· Electrical connection checklist



DANGER!

If supply cord is damaged, it must be replaced by the manufacturer, its service agent or similarly qualified persons in order to avoid a hazard and **SERIOUS INJURY OR DEATH!**



Important:

The manufacturer will not be held liable for damage to persons, animals or property resulting from incorrect installation of the coffee machine.

1. The machine should only be connected to the power supply by qualified personnel. The following safety instructions should be obeyed at all times.
2. Ensure that the electrical requirements stated on the **TECHNICAL SPECIFICATIONS** and on the ratings plate located under the drip tray inside the machine match the specifications of the power supply.
3. Ensure that the domestic electrical supply where the machine is being installed is rated for and able to provide the power required by the machine. Insufficient power supply, wiring, grounding, or insulation can result in overheating and possibility of fire.
4. The coffee machine must be connected to an earth grounded electrical outlet that complies with the regulations in force in the country of installation.

► INSTALLATION AND START UP

· Electrical connection checklist (continued)

5. Ensure that a circuit breaker engineered for the power consumption of the machine is installed to protect the electrical supply, as specified on the ratings plate located under the drip tray.
6. Never connect the machine to the power supply via extension cords, plug adapters, or shared outlets.

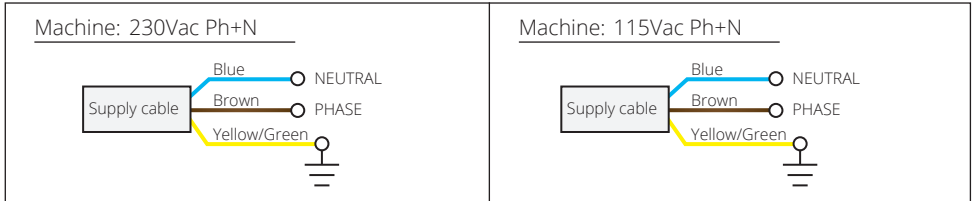

· Initial starting procedure

After carry out the machine installation, follow the next steps for the first start up:

1. Ensure the machine's tank is full of water or domestic water supply is opened at the tap. For the first installation is recommended to refill the water tank manually.
2. Open the steam tap and turn the main power switch on. The machine will refill automatically the steam boiler first (you will hear the pump working).
3. The pump will stop when the steam boiler is completely filled. Close the steam tap.

3a. On 1B versions, when the heating signal lits up, pull the group lever up until water starts to brew in the group head. Then, pull the lever down and wait until the heating signal turns off.

3b. On 2B versions, a 1st installation routine is enabled by software. So, the machine will require to pull the group lever up by showing the icon (fig. 1) on the display. A 90s countdown will start to refill the group boiler. Ensure that water is coming out of the group head when the countdown arrives to 0. Now the heating process will start. Wait until both boilers are heated up.
4. Open the steam tap to ensure that it is working and release the air inside the boiler.
5. Check again if water tank needs to be refilled and proceed to operate with the machine.



ONE 2B 1st start up group boiler refill icon

· Machine handling tips

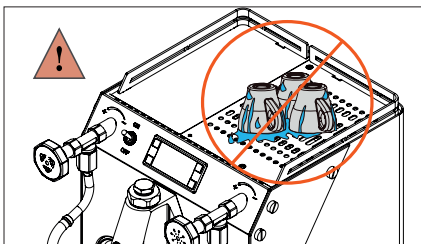

WARNING!

Allowing water to drip into the machine can cause mechanical and electrical damage.

Do not place wet cups directly on the cup shelf. Always thoroughly dry any cups before storing them on the warming shelf.

► OPERATION

· Inserting the portafilter in the group

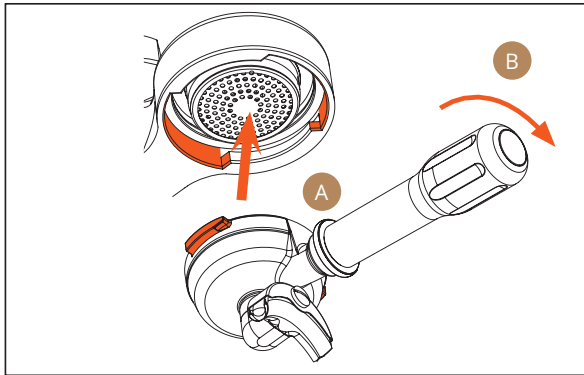

A: Align the portafilter's two flanges with the two slots in the group housing.

B: Insert the portafilter and rotate it counterclockwise until the handle is approximately perpendicular to the face of the coffee machine.

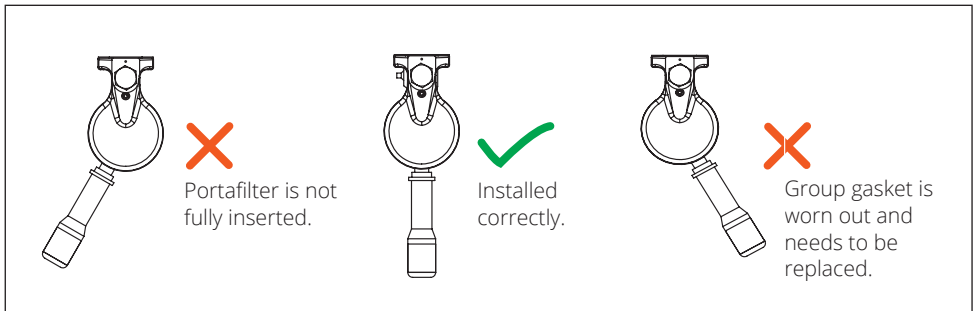

· Espresso brewing

1. Unlock and remove the portafilter from the group head.
2. Fill the filter basket with espresso-grind coffee (approx. 7g for single or 14g for a double espresso).
3. Press the coffee with the coffee tamper.
4. Insert the filled portafilter into the group head and lock it into the correct position.
5. Place the cup(s) under the portafilter outlet(s).
6. Pull the group lever up to brew your espresso.
7. Pull the group lever down to stop the brewing.



WARNING!

Never try to open the portafilter while the machine is in operation! The pressurised hot water could cause scalding or serious injury. After dispensing has finished, wait at least 3 seconds before removing the portafilter.



Pro Tip:

When not in use store the portafilter inserted in the group to keep it warm. This is important to maintain optimal brewing temperature while the espresso is dispensing.

► OPERATION

· Steaming and frothing milk

1. Place the steam wand over the drip tray and open the steam knob/handle for a few seconds to allow condensed water to be ejected. Close the steam knob/handle when only steam is coming out.
2. Immerse the steam wand into the milk, making sure the wand tip is submerged. Open the steam knob/handle again to begin steaming or frothing the milk. Always keep the tip of the steam wand submerged in the milk while steaming! See more on Pro tip below.
3. Once the milk reaches the desired temperature, close the knob/handle and wait for the steaming to stop, then remove the pitcher.
4. After steaming/frothing is finished, position the steam wand over the drip tray and open the steam knob/handle again for a few seconds to purge any milk remaining in the wand. Then wipe down the outside of the steam wand with a damp cloth to prevent nozzle blockage and to keep it clean

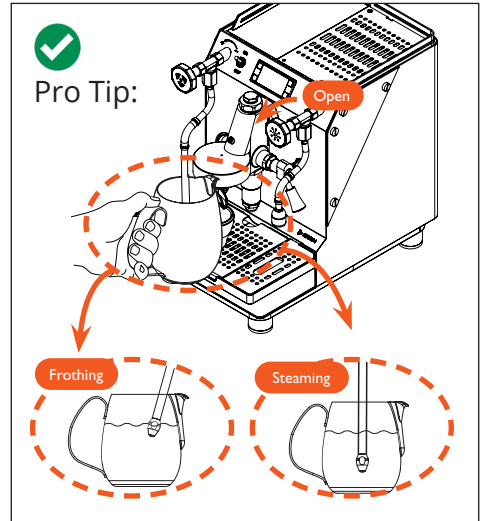
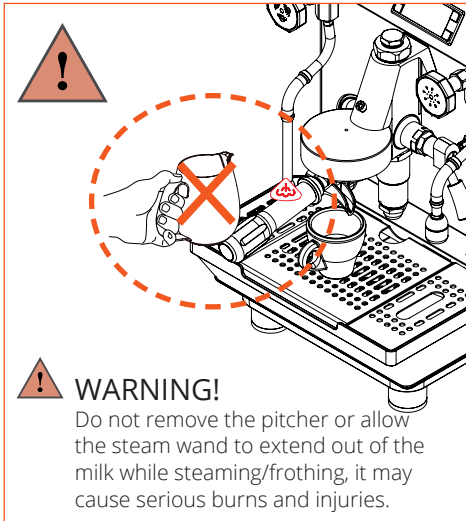

· Dispensing hot water

1. Place a pitcher (or other heat resistant vessel) under the hot water outlet.
2. Open the tap.
3. When the desired amount of hot water is dispensed, close.



WARNING!

Never place hands and fingers directly under the hot water outlet during dispensing to avoid scalding or serious burns.

► CLEANING AND CARE

· Cleaning reminders

- To keep the machine looking and working like new, always follow all the cleaning and care instructions provided in this manual.
- For safety always turn the machine off at the main power switch when cleaning the exterior surfaces.
- All exterior surfaces should be cleaned with a damp, lint-free cloth that will not scratch the machine, glass surfaces can be cleaned with a streak-free glass cleaner and a dry cloth.
- Do not use aggressive cleaning detergents, solvents or degreasers. These may damage the plastic and rubber parts, and will leave unwanted residue

· Daily cleaning – At the end of each working day be sure to:

Steam and hot water

1. Position the steam wand over the drip tray and open the steam tap for one minute to fully flush the wand.
2. Clean the steam wand and the water tap. Be sure that the nozzles are not clogged or partially blocked with milk or other residue. If it's necessary to remove them for cleaning, be careful not to deform or damage any of the components during removal.

Group head and portafilters

1. Clean the shower plate and the group gasket with a soft brush to remove any coffee residue.
2. Run the flushing cycle for each group at the end of each day to prevent coffee residue drying and building up inside the brewing group.

Drip tray & bodyworks

1. Clean the external surfaces of the machine, paying special attention to the glass and stainless steel parts to remove any coffee residue and smudges and fingerprints.
2. Clean the drip tray and the stainless steel insert grid under running water.

· Daily flushing

1. Place the blind filter in the emptied portafilter, then lock the portafilter into the brewing group.
2. Pull up the group lever and keep the pump working for 10 sec and stop 5 sec. Repeat at least 5 times.
3. After cleaning, remember to remove the blind filter and store it in a safe place for the next usage.
4. Clean the internal side of the portafilter before replacing the espresso filter. If needed, let the portafilter soak into warm water or use cleaning detergent for espresso machines.

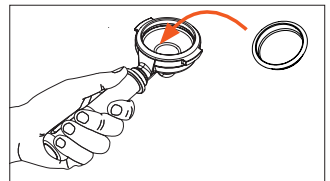

WARNING!

Do not open the group or remove the portafilter until the cleaning has finished! This will release steam and hot water which could result in burns.

► CLEANING AND CARE

· Weekly cleaning or Periodical cleaning and care – Once per week be sure to:

Group head

1. Run the cleaning cycle for each group at the end of each week to thoroughly clean the group head, shower plate and portafilter to ensure great coffee taste. See Weekly cleaning with espresso machine detergent section for details.

Drain hose

1. If the drain hose is installed, clean the drain cup by slowly pouring one liter of warm water into it to dissolve and remove any build-up of coffee residue that often accumulates inside the drain cup and tube.

Tank

1. Remove and clean the water tank with detergent and a soft brush if needed.

Water tank filter

The water tank filter must be replaced when the expiration date is reached (2 months since installation).

Use the following steps to recharge your water softener.

1. Switch the machine off and remove the top panel/cup warming tray.
2. Remove the filter from the tank and install the new one.
3. Replace the top panel/cup warming tray and switch the machine on.

Water mains filter

1. If an external softener is installed, follow and perform the maintenance instructions and respect the replacing or recharging periods described by the manufacturer.

· Weekly cleaning with espresso machine detergent

1. Once a week, add espresso detergent in the blind filter when running the daily flushing.
2. After cleaning, with detergent, the group needs to be flushed. So repeat the process 2 more times to flush out any remaining detergent. Then remove the blind filter and store it in a safe place for the next usage.



► USER PROGRAMMING 1B

· User interface 1B

The machine is equipped a programmable interface that allows users to set or adjust the following features and parameters with guidance from the digital display.

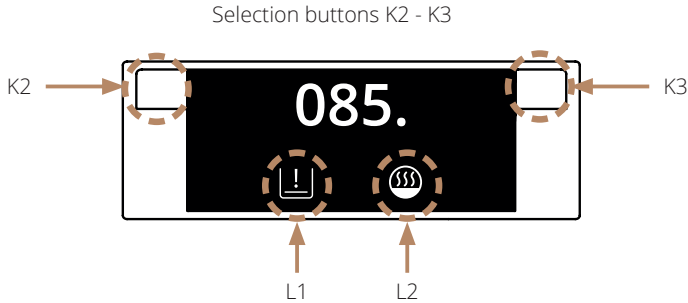

· Adjusting boiler temperature

Use the following steps to adjust the boiler temperature:

- Press the K3 for 5 seconds until 't1' is shown on group display.
- Within 5 seconds, press K2 or K3 to increase or decrease the programmed temperature.
- When the desired temperature is adjusted, just wait 5s until the display shows 't1' again.
- Then you can turn the machine off and on again, or wait 5s to come back to main screen.

► USER PROGRAMMING 2B

· User Interface 2B

The ONE 2B machines are equipped with a programmable 'Barista' interface that allows users to set or adjust the following features and parameters with guidance from the digital display:

- Power off/on (without using the main switch).
- GSP (Gradual Soft Preinfusion) settings. (Rotary Pump versions only).
- Adjust the steam and group boiler temperatures.
- ECO & Stand-by mode settings (set up energy saving mode timers).
- Heating elements On/Off.
- Clock and Date settings (adjust current time and date).
- Shot screen time.
- Counters (volume of water cycled, service intervals, and number of coffees dispensed, etc.).
- Temperature units
- Date format
- USB interface (LFPP version only)
- Barista knob resolution (LFPP version only)



Selection buttons K1 - K2 - K3 - K4

· Barista menu - Access & browsing

To access to the Barista menu, just press **B** (K2)

Then you can browse through the menu using the buttons K1 & K2 with the icons (←) & (→).

Press home icon (🏠) to come back to idle screen.

The icons of each parameter will be shown on the down side of the display and you can access by using K3 & K4.

· Gradual soft preinfusion (GSP) menu (Rotary pump versions only)

On Barista menu, access to GSP (☰) settings.

GSP allows to select the preinfusion time while the machine gradually increases the pump pressure up to the adjusted brewing pressure.

Use the following steps to adjust the GSP settings:

- Activate and deactivate GSP function by choosing between Disable (☒) and Enable (☑)
- When activated, choose the GSP time between Off (Time disabled) to 30 sec. Default setting 10 sec.

Use the ▲/▼ arrows to adjust each setting. Then use the icon (↵) to confirm.

► USER PROGRAMMING 2B

· Temperature adjustment

On Barista menu, access to Temperature () settings.

Use the following steps to adjust the main steam boiler and group boiler temperatures individually:

Group boiler (): Set temperature of the group boiler

Steam boiler (): Set temperature of the steam boiler

Use the ▲/▼ arrows to adjust each setting. Then use the icon () to confirm.



Pro Tip:

Depending on the types/profiles of coffee typically brewed, it may be useful to set a different temperature on the group boiler to extract the very best flavour from each espresso.

· ECO mode

The machine has a standby (energy saver) function which can be activated/deactivated as follows:

Manually:

On main screen, activate and deactivate ECO mode manually with K3.

Automatically:

On Barista menu, access to ECO (**eco**) settings:

- **ECO mode (eco)**: ECO mode will be activated when the machine hasn't been used for the selected time. If the parameter is OFF, ECO mode won't been activated by time.
- **Stand-by mode** (): Stand-by mode will be activated when the machine hasn't been used for the selected time. If the parameter is OFF, Stand-by mode won't been activated by time.

Use the ▲/▼ arrows to adjust each setting. Then use the icon () to confirm.

ECO mode reduces the steam and group boiler temperatures to 105°C and 65°C respectively. This function is recommended during low usage times since it will reduce energy usage but still allows the machine to heat back up to normal operating temperature with just a few minutes when needed.

Stand-by mode disconnects completely the elements.

· Heating element On/Off

On Barista menu, access to Heating element On/Off () settings.

Use this function to activate (ON) or deactivate (OFF) the elements of each boiler.

By default, both boilers are enabled with heating priority assigned to steam boiler. Heating priority functions can be adjusted on technical menu.

Icon () will be shown on main screen when a heating element is disabled.

Use the ▲/▼ arrows to adjust each setting. Then use the icon () to confirm.



Note:

If any of the boiler is switched off, only the boiler set to 'ON' will heat up, no matter what heating priority is selected in the technical menu.

► USER PROGRAMMING 2B

· Clock menu

On Barista menu, access to clock (🕒) settings.
Use the following steps to adjust the time, weekday and date:

Time: On 0-24H format

Weekday: Mon-Sun

Date: DD/MM/YY by default (this format can be modified on Date format settings on Barista menu)

Use the ▲/▼ arrows to adjust each setting. Then use the icon (↵) to confirm.

· Auto On/Off menu

On Barista menu, access to Auto On/Off (🕒) settings.
Use the following steps to activate or deactivate this function and adjust the daily time the machine turns Off (⏻) and the time the machine turns on:

- Activate and deactivate Auto On/Off function by choosing between Disable (☒) and Enable (☑)
- When activated, daily On and Off times can be programmed individually for each weekday.

Use the ▲/▼ arrows to adjust each setting. Then use the icon (↵) to confirm.

 **Pro Tip:**
The Auto On/Off function is useful for programming the machine to be warmed up and ready before the first barista arrives at the start of each day, and saves energy by making sure the machine is shut down automatically at the end of each day.

· Shot screen adjustment

On Barista menu, access to Shot screen (🕒) settings.

Adjust the time that the brewing timer stays on the display after the brewing process is finished. On LFPP machines, the volume accounted by the flowmeter will be shown as well on the display.

Use the ▲/▼ arrows to adjust each setting. Then use the icon (↵) to confirm.

 **Pro Tip:**
After brewing your espresso, you can skip the Shot screen by pressing any button (K1 - K4) on the touchpad.

► USER PROGRAMMING 2B

· Counters menu



On Barista menu, access to Counters () settings.

Use the following steps to access to the machine total counters and to the Cleaning/Service partial counters:

Total counters (): Shows the total number of shots brewed on the group. Adds 1 per each shot (no difference between single or double shot)

Cleaning/Service partial counters (): Shows the partial counters used to trigger the Cleaning/Service alarms.

To reset the partial counter:

- Press on () icon
- Then use the ▲/▼ arrows to select each counter.
- Keep pressed () for 5 sec to reset the partial counter.



Note:

Brewing cycles below 5 seconds won't be accounted.



Note:

Service/Cleaning alarms settings will be adjusted on Technical menu.



Note:

Volume related counters will be available on LFPP machines only.



Pro Tip:

The counters can be useful for calculating the number of coffees dispensed over a day, week or month, which is helpful in calculating expenses, when machine cleaning or service is needed, and other important machine related information.

· Temperature units

On Barista menu, access to Temperature units () settings.

Use the ▲/▼ arrows to select between °C or °F for temperature units.
Then use the icon () to confirm.

· Date format

On Barista menu, access to Date format () settings.

Use the ▲/▼ arrows to select between DD/MM/YY; YY/MM/DD or MM/DD/YY for date format.
Then use the icon () to confirm.

► USER PROGRAMMING 2B

· USB communication (LFPP version only)

On Barista menu, access to USB communication (📁) settings.

USB communication allows to import the welcome logo and to import/export LFPP recipes via USB:

Import logo (📁):

- Copy the desired logo image onto an empty USB stick (NOTE: image must be in .bmp format, sized 128x64 pixels, black and white colour).
- Insert the USB stick into the USB port at the back of the machine, then press import (📁) to upload the image.

Import recipe (📁):

- Copy the desired recipes files (files must be in .txt format, named IMPONE.txt) onto an empty USB stick.
- Insert the USB stick into the USB port at the back of the machine, then press import (📁) to upload the recipes.

Export recipe (📁):

- Insert an empty USB stick into the USB port at the back of the machine.
- Press export (📁) to download the recipes from the machine onto the USB-stick. The machine will generate an EXPONE.txt file and copy it to the USB stick.

· Barista knob resolution (LFPP version only)

On Barista menu, access to Barista knob resolution (⚙️) settings.

Barista knob resolution allows to adjust the resolution of each click of the Barista knob when brewing with LFPP system on Barista mode.

Use the ▲/▼ arrows to adjust each setting. Then use the icon (↩️) to confirm.

► PRESSURE PROFILING MENU

· Manual mode: Access

1. From idle user display,
2. Press the pressure profiling knob inward.
3. Manual mode icon will be shown on display.

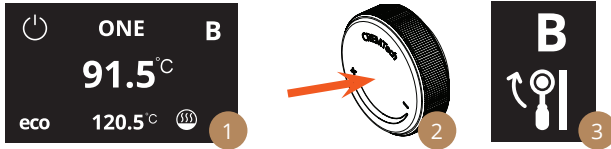

· Manual mode: Initial PP pressure

Settings explanation	Choices / limits for adjustment	Default initial setting
Choose the initial pressure by rotating the PP knob	2-12 Bar	2 Bar



· Manual mode: Run the shot



- When you have selected the initial pressure of the shot, pull the group lever up to start brewing.
- Use the 'Barista knob' to adjust the brew pressure during the extraction.

· Manual mode: Save recipe



► PRESSURE PROFILING MENU

· Recipe mode: Choose recipe

1. From idle user display, rotate the PP knob to browse through the recipes.
2. Select the recipe by pressing the PP knob.

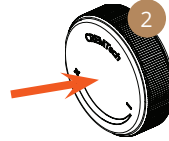

· Recipe mode: Recipe graph information

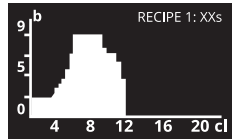

· Recipe mode: Run the shot



► MACHINE ALERTS









· Alarms & Warnings

To alert users that routine service of the machine is due or against a situation that could possibly cause damage to the machine, ONE has the following alerts programmed into its software:

1B versions

Error Code	Alarm Name	Warning / Alarm	Solution
A1	NTC is short-circuited	Alarm	Call a service technician to replace it
A2	NTC is not connected	Alarm	Call a service technician to replace it
A4	Steam Boiler FillingUp timeout	Alarm	"Turn the main switch off and on again. Check that the machine is receiving water."
A7	Drink too long	Warning	Pull the group lever down to remove the alarm
A10	Empty tank	Alarm	Refill the tank.
A11	Water tank not in place	Alarm	Put the tank in the correct position

2B versions

Error Code	Alarm Name	Warning / Alarm	Solution
	Steam boiler sensor AL1 Temp. Probe shortcircuited AL2 Temp. Probe unconnected"	Alarm	Call a service technician to replace it
	Group boiler sensor AL1 Temp. Probe shortcircuited AL2 Temp. Probe unconnected"	Alarm	Call a service technician to replace it
	Steam boiler FillingUp timeout	Alarm	Turn the main switch off and on again. Check that the machine is receiving water."
	Empty tank	Alarm	Refill the tank.
	Water tank not in place	Alarm	Put the tank in the correct position
	Drip tray full	Alarm	Empty the drip tray
	Maintenance / Cleaning (if enabled)	Warning (Blinks)	Do the maintenance / Cleaning. Reset counter on Barista menu.
	Filter reset	Warning (Blinks)	Replace water filter. Reset counter on Barista menu.

► TROUBLESHOOTING

· Machine faults

Problem	Possible cause	Solution
The machine does not start up when turned on	The plug is not correctly inserted into the power socket	Check that the plug is correctly inserted and that the power socket is operational.
	The circuit breaker and/or differential are disconnected.	Check that they are connected.
	The cable and/or plug are damaged.	Call service personnel to replace them.
The steam wand does not dispense steam	The steam wand is clogged with dried milk.	Clean the wand and, if necessary, remove the nozzle and unplug it using a pin or needle.
Water is found underneath the machine	The drainage tube is blocked with used grounds/rubbish.	Clean the drainage tube.

· Brewing faults

Problem	Possible cause	Solution
Coffee dispensing is too fast:	The coffee grind is too coarse.	Switch to a finer grind of espresso.
Coffee dispensing is too slow:	The coffee grind is too fine.	Switch to a coarser grind of espresso.

· Limescale faults

Problem	Possible cause	Solution
Coffee dispensing temperature is too cold:	Heat-exchanger outlet pipes are clogged with limescale.	Turn off the machine at the switch and contact a technician to make needed repairs.
Brewing groups do not dispense water:	Water system is clogged with limescale.	Turn off the machine at the switch and contact a technician to make needed repairs.

For the warranty to be valid the conditions for maintenance must have been followed according to our instructions, proper precaution has been made and warranty claim been issued without delay.

The affected equipment may not be used during awaiting service if there is any risk that the damage or defect would worsen.

The warranty will not cover consumption supplies such as glassware, normal maintenance such as cleaning of filters, contaminations in water, lime, incorrect voltages, pressure or adjustment of water amounts.

The warranty will not cover damages of defects caused by incorrect handling and operation of the appliance.

**For service
Please contact your dealer**

Your Dealer

Crem International (Shanghai) Co., Ltd
Building 5, No.521-551, Kangyi Road, Pudong New Area, Shanghai 201315, China.

Crem International Spain S.L.U.
C/ Comerç nº 4 - Pol. Ind. Alcodar, 46701 - Gandía (Valencia - Spain)



www.creminternational.com