

GAGGIA

MILANO



ENGLISH

FRANÇAIS

GAGGIA MAGENTA

PLUS

RI8699 (SUP 051) RI8700 (SUP 051W)

Operating instructions
Mode d'emploi

CE



02

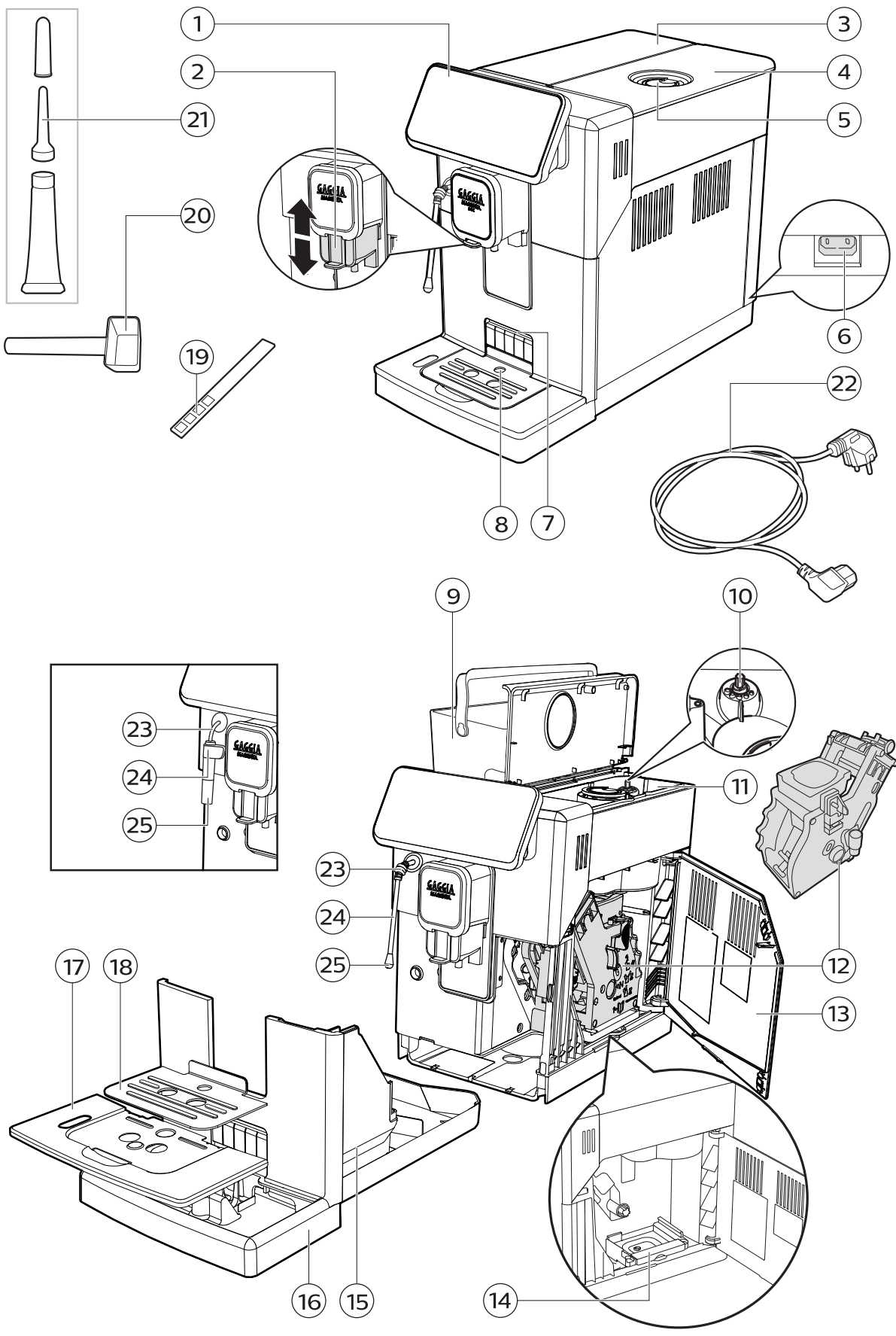

First installation / Première installation

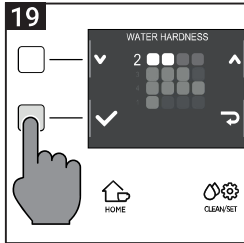
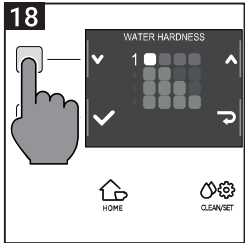
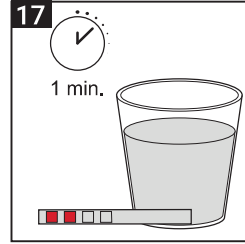
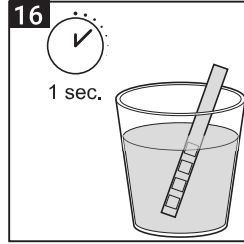
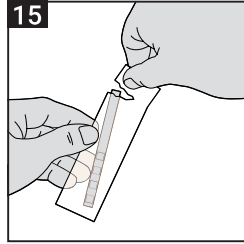
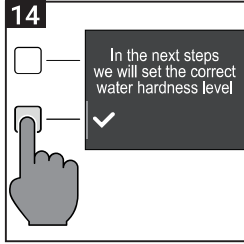
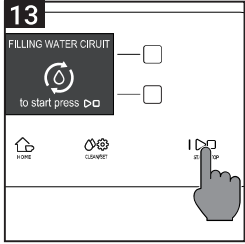
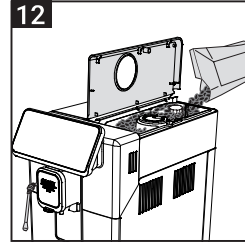
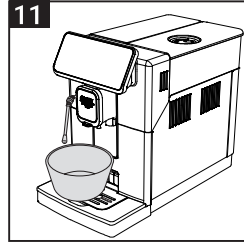
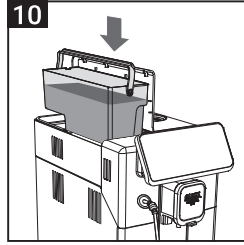
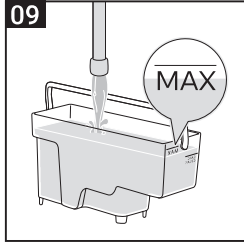
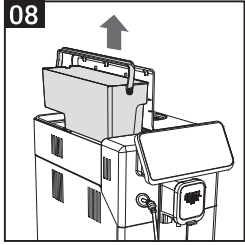
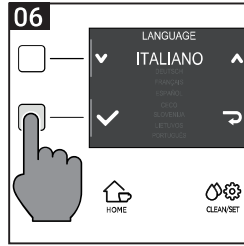
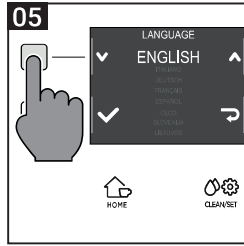
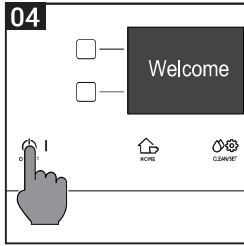
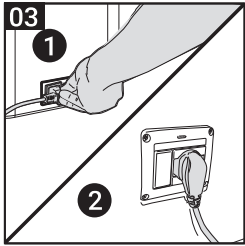

IMPORTANT SAFEGUARDS

When using electrical appliances, basic safety precautions should always be followed, including the following:

1. Read all instructions.
2. Do not touch hot surfaces. Use handles or knobs.
3. To protect against fire, electric shock and injury to persons do not immerse cord, plugs, or appliance in water or other liquid.
4. Close supervision is necessary when the appliance is used by or near children.
5. Unplug from outlet when not in use and before cleaning. Allow to cool before putting on or taking off parts, and before cleaning the appliance.
6. Do not operate any appliance with a damaged cord or plug or after the appliance malfunctions, or has been damaged in any manner. Return appliance to the nearest authorized service facility for examination, repair or adjustment.
7. The use of accessory attachments not recommended by the appliance manufacturer may result in fire, electric shock or injury to persons.
8. Do not use outdoors.
9. Do not let cord hang over edge of table or counter, or touch hot surfaces.
10. Do not place on or near a hot gas or electric burner, or in a heated oven.
11. Always attach plug to appliance first, then plug cord into wall outlet. To disconnect, turn any control to "off", then remove plug from wall outlet.
12. Do not use appliance for other than intended use.
13. Save these instructions.

SAVE THESE INSTRUCTIONS

CAUTION

This appliance is for household use only. Any servicing, other than cleaning and user maintenance, should be performed by an authorized service center. Do not immerse machine in water. To reduce the risk of fire or electric shock, do not disassemble the machine. There are no parts inside the machine serviceable by the user. Repair should be done by authorized service personnel only.

1. Check voltage to be sure that the voltage indicated on the nameplate corresponds with your voltage.
2. Never use warm or hot water to fill the water tank. Use cold water only.
3. Keep your hands and the cord away from hot parts of the appliance during operation.
4. Never clean with scrubbing powders or harsh cleaners. Simply use a soft cloth dampened with water.
5. For optimal taste of your coffee, use purified or bottled water. Periodic descaling is still recommended every 2-3 months.
6. Do not use caramelized or flavored coffee beans.

INSTRUCTIONS FOR THE POWER SUPPLY CORD

- A.** A short power-supply cord (or detachable power-supply cord) is to be provided to reduce risks resulting from becoming entangled in or tripping over a longer cord.
- B.** Longer detachable power-supply cords or extension cords are available and may used if care is exercised in their use.
- C.** If a long detachable power-supply cord or extension cord is used,
 1. The marked electrical rating of the detachable power-supply cord or extension cord should be at least as great as the electrical rating of the appliance
 2. If the appliance is of the grounded type, the extension cord should be a grounding-type 3-wire cord, and
 3. The longer cord should be arranged so that it will not drape over the counter top or table top where it can be pulled on by children or tripped over.

Important safety information

This machine is equipped with safety features. Nevertheless, read and follow the safety instructions carefully and only use the machine as described in these instructions, to avoid accidental injury or damage due to improper use of the machine. Keep this safety booklet for future reference.

Warning

General

- Check if the voltage indicated on the machine corresponds to the local mains voltage before you connect the appliance.
- Connect the machine to an earthed wall socket.
- Do not let the power cord hang over the edge of a table or worktop and do not let it touch hot surfaces.
- To avoid the danger of electric shock, never immerse the machine, mains plug or power cord in water or any other liquid.
- Do not pour liquids on the power cord connector.
- To avoid the danger of burns, keep body parts away from hot water jets produced by the machine.
- Do not touch hot surfaces. Use handles and knobs.
- Switch off the machine with the main switch located on the back (if present) and remove the mains plug from the wall socket:
 - If a malfunction occurs.
 - If you are not going to use the appliance for a long time.
 - Before you clean the machine.
- Pull at the plug, not at the power cord.
- Do not touch the mains plug with wet hands.
- Do not use the machine if the mains plug, the power cord or the machine itself is damaged.
- Do not make any modifications to the machine or its power cord.
- Only have repairs carried out by a service center authorized by Gaggia to avoid a hazard.
- The machine should not be used by children younger than 8 years old.
- This machine can be used by children aged from 8 years and above and by persons with reduced physical, sensory or mental capabilities or lack of experience and knowledge if they have been given supervision or instruction concerning use of the machine in a safe way and if they understand the hazards involved.
- Cleaning and user maintenance shall not be made by children unless they are older than 8 and supervised.
- Keep the machine and its cord out of the reach of children aged less than 8 years.
- Children should be supervised to ensure that they do not play with the machine.
- Never insert fingers or other objects into the coffee grinder.
- Be careful when you dispense hot water.
Dispensing may be preceded by small jets of hot water. Wait until the end of the dispensing cycle before you remove the hot water dispensing spout.

Caution

General

- This machine is intended for normal household use only. It is not intended for use in environments such as staff kitchens of shops, offices, farms or other work environments.
- Always put the machine on a flat and stable surface. Keep it in upright position, also during transport.
- Do not place the machine on a hotplate or directly next to a hot oven, heater or similar source of heat.
- Only put roasted coffee beans in the bean hopper. Putting ground coffee, instant coffee, raw coffee beans or any other substance in the coffee bean hopper may cause damage to the machine.
- Let the machine cool down before you insert or remove any parts. The heating surfaces may retain residual heat after use.
- Never fill the water tank with warm, hot or sparkling water, as this may cause damage to the water tank and the machine.
- Never use souring pads, abrasive cleaning agents or aggressive liquids such as petrol or acetone to clean the machine. Simply use a soft cloth dampened with water.
- Descal your machine regularly. The machine indicates when descaling is needed. Not doing this will make your appliance stop working properly. In this case repair is not covered by your warranty.
- Do not keep the machine at temperatures below 0°C/32°F. Water left in the heating system may freeze and cause damage.
- Do not leave water in the water tank when you are not going to use the machine for a long period of time. The water can become contaminated. Use fresh water every time you use the machine.
- Never use any accessories or parts from other manufacturers or that Gaggia does not specifically recommend. If you use such accessories or parts, your warranty becomes invalid.
- Regular cleaning and maintenance prolongs the lifetime of your machine and ensures optimum quality and taste of your coffee.
- The machine is exposed continuously to moisture, coffee and scale. Therefore it is very important to regularly clean and maintain the machine as described in the user manual and shown on the website. If you do not perform these cleaning and maintenance procedures, your machine eventually may stop working. In this case repair is not covered by warranty.
- Do not clean the brew group in the dishwasher and do not use washing-up liquid or a cleaning agent to clean it. This may cause the brew group to malfunction and may have a negative effect on the coffee taste.
- Do not dry the brew group with a cloth to prevent fibers from collecting inside the brew group.
- Never drink the solution dispensed during the descaling process.
- Only put preground coffee into the preground coffee compartment. Other substances and objects may cause severe damage to the machine. In this case, repair is not covered by your warranty.
- The machine shall not be placed in a cabinet when in use.

Machines with milk carafe

Warning

- To avoid the danger of burns, be aware that dispensing may be preceded by jets of milk and steam. Wait until the end of the cycle before you remove the milk carafe.

Caution

- Make sure that the milk carafe is installed and the milk dispensing spout is open before you select a milk-based coffee beverage or milk froth.
- Do not put any other liquids in the milk jug/carafe than water (for cleaning) or milk.
- Do not clean the milk carafe in the dishwasher.

Machines with classic milk frother / pannarello

Warning

- To avoid the danger of burns, be aware that dispensing may be preceded by small jets of hot water.
- Never touch the classic milk frother with bare hands, as it may become very hot. Use the appropriate protective handle only.

Caution

- After frothing milk, quickly clean the classic milk frother by dispensing a small quantity of hot water into a container. Then remove the external part of the classic milk frother and wash it with lukewarm water.

Machines with automatic milk frother / cappuccinatore / Capp in Cup system

Warning

- To avoid the danger of burns, be aware that dispensing steam or hot water may be preceded by small jets of hot water. Never touch the hot water/steam dispensing spout with bare hands, as it may become very hot. Use the appropriate protective handle only.
- During dispensing make sure that the spout of the "Capp in Cup" system, if present, is oriented towards the cup and not towards yourself.
- Never drink the solution dispensed during the monthly cleaning procedure of the automatic milk frother.

Caution

- For hygienic reasons, make sure that the outer surface of the hot water/steam dispensing spout is clean.
- After frothing milk, quickly clean the automatic milk frother by dispensing a small quantity of hot water. Follow the cleaning instructions in the user manual.
- Be careful, the hot water/steam dispensing spout could be hot if the machine has recently been used.
- Do not push the rubber fitting too far on the hot water/steam dispensing spout when you insert it. In this case, the automatic milk frother would not work correctly as it would not be able to suck up milk.



Electromagnetic fields (EMF) ---

This machine complies with all applicable standards and regulations regarding exposure to electromagnetic fields.

Recycling ---



- This symbol means that this product shall not be disposed of with normal household waste (2012/19/EU).
- Follow your country's rules for the separate collection of electrical and electronic products. Correct disposal helps prevent negative consequences for the environment and human health.

Warranty and support ---

For service or support, contact your local dealer or an authorized service center.

Contact details are included in the warranty booklet supplied separately or visit www.gaggia.com or www.gaggia.it.



Congratulations on your purchase of Gaggia Magenta!
This easy-to-use machine guarantees excellent results every day.
Thanks to the intuitive interface, you can choose among 5 beverages and customise them according to your preferences.
Before being packed, each of our high-quality machines undergoes rigorous testing in our laboratories in order to ensure its correct operation. Some coffee residue might be found in your machine, since real coffee is normally used during testing. However, this does not compromise the integrity of the product. Please be assured that this is a brand new machine.
In this user manual you will find all the information you need to install, use, clean and descale your machine. Before using it for the first time, please read carefully the safety manual provided separately and store it for future use.

Contents

Machine overview (Fig.2)	12
Steam wand version	12
Classic pannarello version	12
Control panel and display	13
Control panel overview (Fig. 1)	13
Multifunction buttons	13
First installation	14
Manual rinse cycle	14
Measuring water hardness	15
INTENZA+ water filter	15
Installing the INTENZA+ water filter	16
Replacing the INTENZA+ water filter	16
Types of beverage	17
Espresso tray	18
Coffee brewing	18
Brewing coffee using coffee beans	18
Brewing coffee using pre-ground coffee	19
How to froth milk	20
Model with the classic pannarello	20
Model with steam wand	20
Dispensing hot water	21
Customising beverages and saving settings (MEMO)	22
Beverage Customisation	22
Coffee grind settings	23
Cleaning and maintenance	24
Cleaning table	24
Cleaning the steam system	25
Cleaning the brew group	26
Lubricating the brew group	28
Descaling	29
Descaling procedure	29
What to do if the descaling process is interrupted	30
Other settings	31
Language	31
Water filter	31
Stand-by Time	31
Units	32
Water hardness	32
Beverage counter	32
Button sound	32
Factory settings	32
Error code key	33
Troubleshooting	34
GAGGIA accessories	36
Technical specifications	37

Machine overview (Fig.2)

1	Control panel	12	Brew group
2	Adjustable coffee dispensing spout	13	Service door
3	Water tank lid	14	Coffee residues drawer
4	Coffee bean container lid	15	Coffee pucks container
5	Pre-ground coffee compartment	16	Drip tray
6	Power cord socket	17	Drip tray grid
7	Espresso tray insertion slot	18	Espresso tray
8	Full drip tray indicator	19	Water hardness tester
9	Water tank	20	Grinder adjustment key and pre-ground coffee measuring spoon
10	Grinder adjustment knob	21	Lubricant
11	Coffee bean container	22	Power cord

Steam wand version

23	Steam wand handle	25	Steam wand nozzle
24	Steam wand		

Classic pannarello version

23	Steam tube	25	Classic pannarello
24	Classic pannarello handle		

Control panel and display

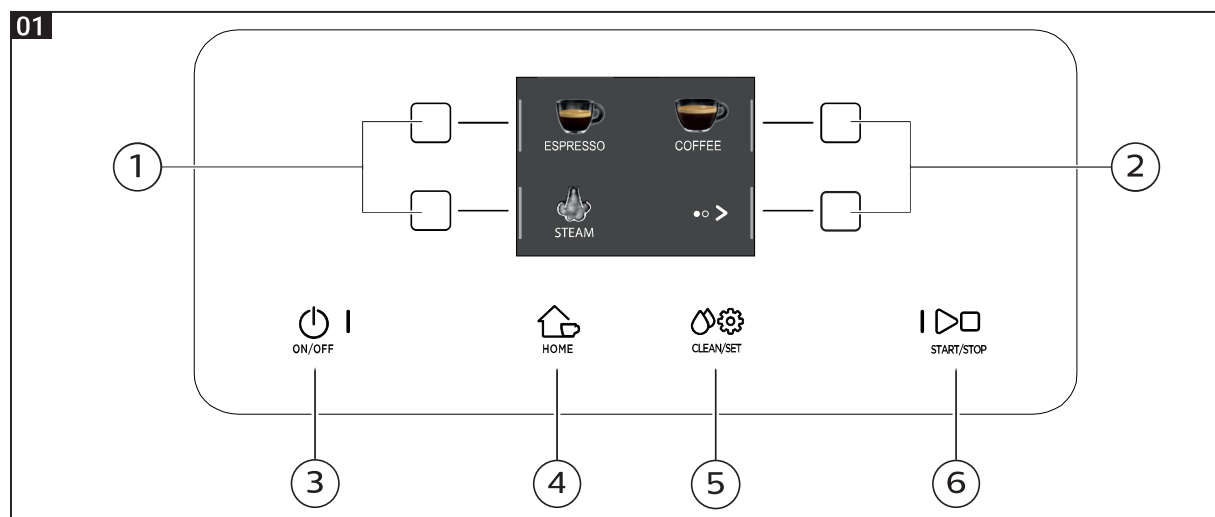

Control panel overview (Fig. 1)

1/2	MULTIFUNCTION buttons	Select the function shown on the display.
3	ON/OFF button	To switch the machine on or off, by keeping the button pressed for a few seconds.
4	HOME button	To open the beverage menu.
5	CLEAN/SET button	To open the cleaning and settings menu.
6	START/STOP button	To start/stop the dispensing of the selected beverage, or to start/stop the procedure indicated on the display.

Note: HOME and CLEAN/SET also work as ESC buttons. You can exit the screen by pressing one of the two buttons to go back to the main menu. This will not be possible if you have already accessed a function or a programme.

Multifunction buttons

The multifunction buttons on the sides of the display are used to select the function or the beverage to which they refer at that time.

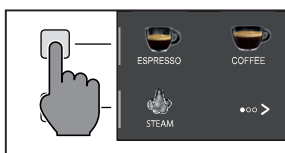

Note: To make the reading of this manual easier, <<press the " " button>> means <<press the button related to " ">>.

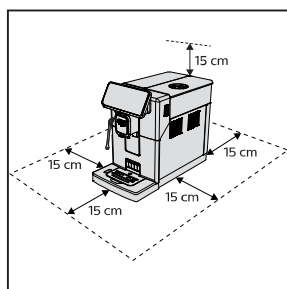

First installation

Before using the machine, it is essential to follow a few simple steps, clearly described in the explanatory drawings you found in the quick guide at the beginning of this instruction manual.

Note: for even tastier coffee, we recommend that you initially prepare 5 cups of coffee to allow the machine to self-adjust.

Manual rinse cycle

During the first installation or after a long period of machine inactivity, a manual rinse cycle must be carried out.

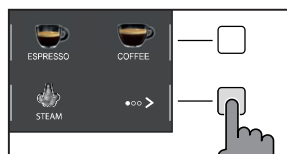

- 1 Place a container under the coffee dispensing spout, scroll through the different pages and select a "ESPRESSO LUNGO".



- 2 Press the "☕" button until "☕" is selected, without adding pre-ground coffee.

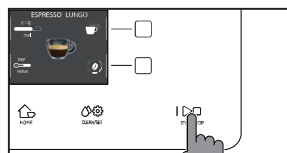

- 3 Press the **START/STOP** button to start dispensing. The machine will dispense hot water.

- 4 Empty the container and if present remove the classic pannarello from the steam tube.



- 5 Place the container under the steam wand and select "HOT WATER".

- 6 Press the **START/STOP** button to start dispensing.

- 7 Empty the container and repeat steps 5 to 7 until the water tank is empty.



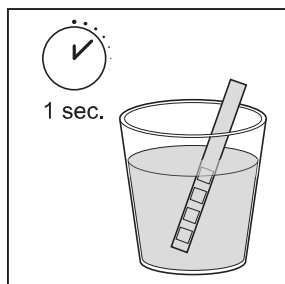

- 8 When finished, refill the water tank to the MAX level. The machine is now ready for use.

Measuring water hardness

You will need to set the water hardness when you install your machine. Take the water hardness measuring strip contained in the packaging and follow the steps shown on the display during the installation phase. To change the water hardness later, press the **CLEAN/SET**   button, then select "SETTINGS", and once in the settings menu, please select "WATER HARDNESS".



- 1 Immerse the water hardness measuring strip in a glass of water for 1 second. Remove the strip from the water and wait 1 minute.
- 2 Note how many squares turn red.
- 3 Use the green "▼" and "▲" buttons to select the water hardness according to the table below. Confirm the setting by pressing "✓".

Small red squares	Value to set	Water hardness	INTENZA+
	1	very soft water	A
	2	soft water	A
	3	hard water	B
	4	very hard water	C

INTENZA+ water filter

We recommend using the INTENZA+ water filter to limit limescale formation. This ensures a longer operating life of your machine and a better coffee aroma over time.

Water is an essential element in brewing coffee. Therefore, it is extremely important that water is always filtered adequately.

The INTENZA+ water filter prevents the formation of mineral deposits, improving the quality of the water.

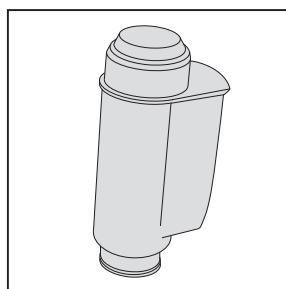

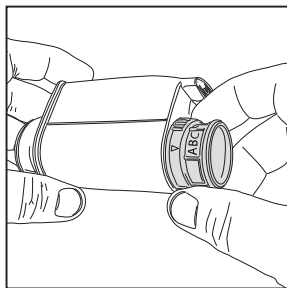
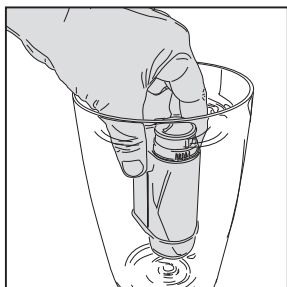

Installing the INTENZA+ water filter



Immerse the INTENZA+ water filter in cold water, in a vertical position and with the opening facing upwards. Press both sides of the filter gently to let air bubbles out.

Remove the INTENZA+ water filter from the water. Set the machine according to the detected water hardness - see the "Measuring water hardness" chapter. On the filter base, please set one of the following:

- A** = soft water – 1 or 2 small squares
- B** = hard water (standard) – 3 small squares
- C** = very hard water – 4 small squares

Place the INTENZA+ filter in the water tank, ensuring it is correctly positioned. Refill the water tank and place it back in its housing.

- 1 Press the **CLEAN/SET**  button and then the "SETTINGS" button.
- 2 Select "WATER FILTER" and press the "✓" button.
- 3 Select "ACTIVATE" and follow the instructions on the display to activate the filter correctly.

Note: you can pause the filter activation procedure by pressing the **START/STOP**  button. To resume the filter activation procedure, press the **START/STOP**  button again.

Replacing the INTENZA+ water filter

When the INTENZA+ water filter expires, the warning message appears on the display.

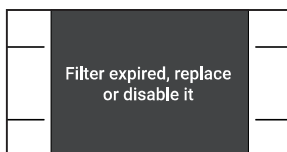



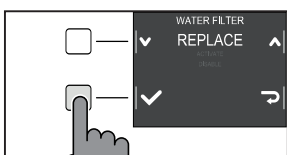

- 1 Replacement or deactivation can be executed by pressing the **CLEAN/SET**  button and then the "SETTINGS" button.
- 2 Select "WATER FILTER" then press the "✓" button.
- 3 **Select** "REPLACE" to change the filter or "DISABLE" if you do not intend to use the filter. Confirm with the "✓" button.

Follow the instructions shown on the display to activate the filter.



Types of beverage

Original recipe		Description
Espresso	Coffee 40 ml	The espresso is known around the globe as true Italian coffee. Served in a small cup, its unmistakable features are a full and intense aroma and a top layer of compact, natural "crema". It is the result of the pressurized hot water extraction process invented by Achille Gaggia in 1938.
		
Espresso lungo	Coffee 80 ml	The long espresso is an espresso with a longer extraction time. It is more diluted, with a different aromatic intensity and a higher caffeine content. It is served in a medium-sized cup.
		
Coffee	Coffee 120 ml	Coffee is a beverage prepared with more water than espresso. It has a lighter aroma and is served in a medium-large cup.
		
Americano	Coffee 40 ml Water 110 ml	The americano is a less intense long coffee, prepared with an espresso to which hot water is added.
		
Hot water	Water 150 ml	Hot water can be used to prepare hot teas, infusions and instant beverages.
		

Note: In the original recipes the beverages are all set to an average temperature and aroma intensity.

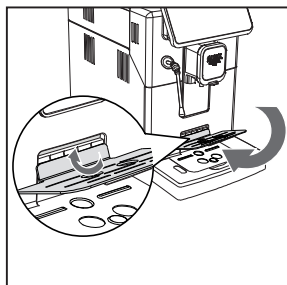
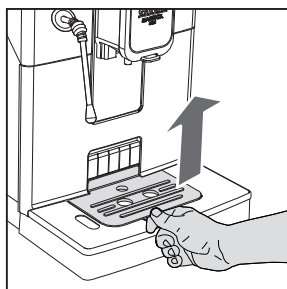

Espresso tray

This machine was designed to guarantee flawless results, from a traditional espresso to a number of different beverages. If you want to enjoy an Italian espresso with a delicious layer of its natural "crema" on top and as tradition dictates, we suggest your using of the "Espresso Tray" which is specifically designed for this purpose. This tray allows the use of traditional espresso cups, ensuring the perfect height for a compact, homogeneous "crema" and a splash-free brewing.

Lift the espresso tray off the grid of the drip tray and place it into the dedicated slot as shown in the drawing.

Coffee brewing

Brewing coffee using coffee beans

Warning: only use coffee beans when making espresso. Do not put any pre-ground, unroasted, freeze-dried or instant coffee in the coffee bean container, as they may damage the machine.

Tip: Preheat the cups with hot water to enjoy a warmer coffee.

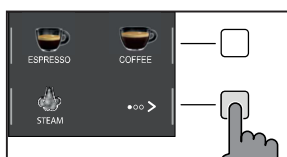
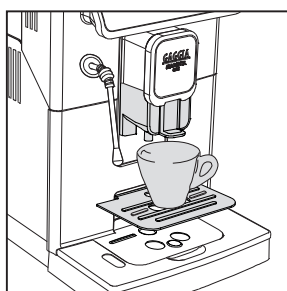

- 1 Upon positioning the espresso tray, place a cup under the coffee dispensing spout, raise or lower the coffee dispensing spout according to the size of the cup you are using.
Press the **HOME**  button to access the beverage menu.

- 2 Browse the various pages to find and select the desired coffee.

- 3 Upon selection of your desired coffee, it is possible to prepare two cups at the same time- besides AMERICANO, using the "  " button.

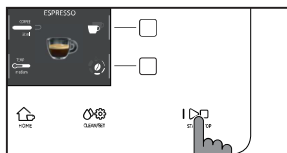

- 4 Finally, press the **START/STOP**  button to start brewing.

Note: you can interrupt the brewing at any time by pressing the **START/STOP**  button.

If you wish to customise the settings of a specific beverage, please refer to the “Beverage customisation” chapter.

Brewing coffee using pre-ground coffee

Use the measuring scoop provided to insert the correct dose in the pre-ground coffee compartment.

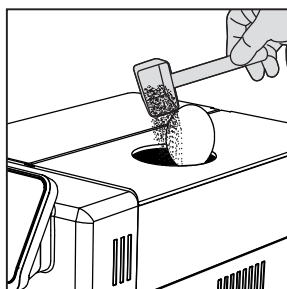

- 1 Lift the lid of the pre-ground coffee compartment and add a little less than one level scoop of pre-ground coffee.

Warning: do not insert anything other than pre-ground coffee, as it may damage the machine.

- 2 Place a cup under the coffee dispensing spout and select the desired beverage.

- 3 Press the “” button until “” is selected.

Note: The “pre-ground coffee” function excludes the possibility of brewing two cups of coffee at the same time, as well as the aroma setting. In fact, these are only possible with coffee beans.

- 4 Press the **START/STOP**  button to start brewing the coffee.



If you wish to customise the settings of a specific beverage, please refer to the “Beverage customisation” chapter.

Note: you can interrupt the brewing at any time by pressing the **START/STOP**  button.

How to froth milk

Tip: use cold milk (at a temperature of around 5 °C) with a protein content of at least 3% to ensure optimum results for the froth. You can use either whole milk or semi-skimmed milk. You can also use skimmed milk, soy milk or lactose-free milk.

Model with the classic pannarello

- 1 Fill 1/3 of a jug with milk
- 2 Press the **HOME**  button to open the beverage menu.
- 3 Insert the classic pannarello into the milk. From the beverage selection menu, select "STEAM" and press the **START/STOP**  button to start frothing.

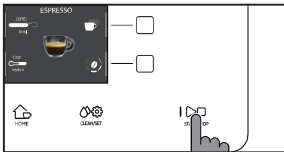
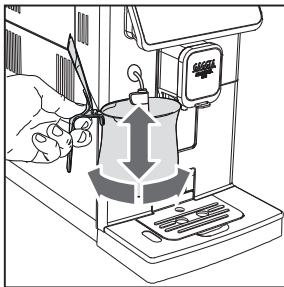
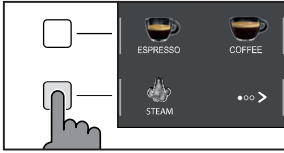

- 4 Froth the milk by gently swirling the carafe and moving it up and down.

- 5 When the milk froth comes to the desired consistency. Press the **START/STOP**  button to stop steam dispensing. Wait until dispensing stops completely before removing the carafe.

Note: After frothing milk, clean the circuit by dispensing a small quantity of hot water.

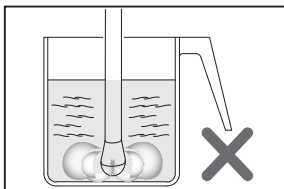
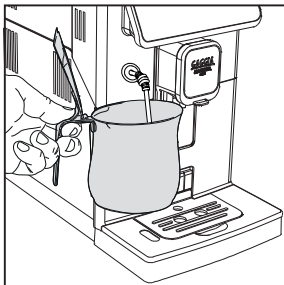

Model with the steam wand

- 1 Fill 1/3 of a jug with milk.
- 2 Place the steam nozzle just below the surface of the milk; if it has been inserted too deep, the milk will not be frothed; if it has not been inserted deep enough, big bubbles will be produced.

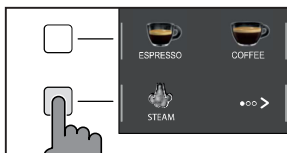

- 3 It is important to keep the nozzle not at the centre but close to the edge of the jug, with an appropriate angle to produce a stronger vortex.



- 4 Press the **HOME**  button to open the beverage menu. Select "STEAM" and press the **START/STOP**  button to start frothing

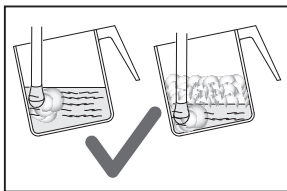

- 5 To froth the milk correctly, the steam nozzle must always be in contact with the milk and not with the froth. Therefore, as the layer of froth increases, the jug must be slightly raised trying to keep the nozzle in contact with the milk, without touching the bottom of the jug. Once the desired frothing has been achieved, the steam nozzle must be pushed further to heat the milk well.

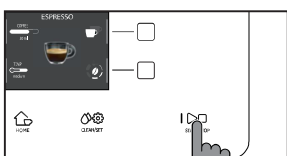

- 6 When the milk froth comes to the desired consistency. Press the **START/STOP**  button to stop steam dispensing. Wait until dispensing stops completely before removing the jug.

Note: It is advisable to always keep a hand on the rounded part of the jug to feel the temperature increase of the milk.

Note: After frothing the milk, to make the froth more compact, it is advisable to lightly tap the jug on a flat surface and leave it to rest for at least 30 seconds. The milk will become more homogeneous.

Note: After frothing milk, clean the circuit by dispensing a small quantity of hot water. Be careful as hot water or steam sprays might be present.

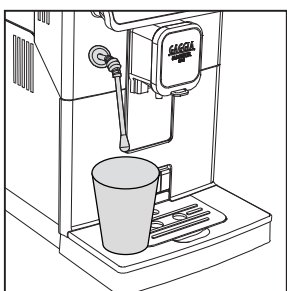

Dispensing hot water

Warning: when the machine starts preparing hot water, the classic pannarello or steam wand (depending on the model) spout may spray steam and hot water.

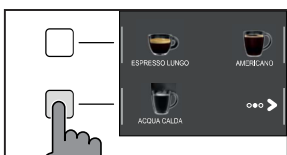

- 1 Place a container under the classic pannarello or steam wand (depending on the model).



- 2 Press the **HOME**  button and using the "➤" button browse the various pages.
- 3 Press the "HOT WATER" button. Finally, press the **START/STOP**  button to commence dispensing.

Note: you can interrupt dispensing at any time by pressing the **START/STOP**  button.

If you wish to customise the settings of a specific beverage, please refer to the "Beverage Customisation" chapter.

Customising beverages and saving settings (MEMO)

This machine allows you to change the settings of a beverage according to your preferences and save them (MEMO), by overwriting the previous settings.

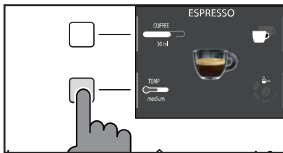

Beverage Customisation

- 1 Press the **HOME**  button.
- 2 Select your beverage.
- 3 All the settings that can be adjusted and/or selected are displayed on the screen. Based on the type of beverage, you can adjust and/or select:
 - coffee amount;
 - coffee temperature;
 - brewing two cups at a time;
 - pre-ground coffee use;
 - aroma intensity (only when using coffee beans);





- 4 Once the "COFFEE  " button has been pressed, use the green "+" and "-" buttons to select the desired amount. Press "✓" to confirm and return to the previous screen, where the new quantity will be displayed.

- 5 Press the "TEMP  " button repeatedly to adjust the temperature of the beverage among the following options:
 - low;
 - medium;
 - high;

- 6 Press " " button to brew two cups, or " " for a single cup. The picture of the beverage in the centre of the display will indicate the number of cups selected.

Note: this function is not available for beverages with milk, AMERICANO and HOT WATER.

- 8 To change the intensity of the aroma or select the pre-ground, press the " " button. You can choose among 5 different degrees of intensity. Every time you press the " " button, the aroma strength changes by one degree. The display shows the selected intensity or the selection of the pre-ground.

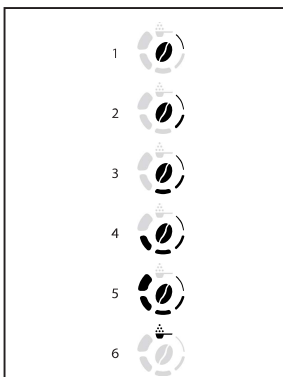

- 1 Very light
- 2 Light
- 3 Normal
- 4 Strong
- 5 Very strong
- 6 Pre-ground.

Note: the function Pre-ground allows the brewing of just one coffee at a time.

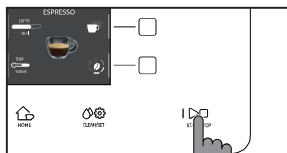

- 9 Once the beverage has been customised according to your preferences, you can proceed with dispensing it by pressing **START/STOP** button.
- 10 If you have changed any of the parameters listed above, you will be asked at the end of dispensing if you would like to save the recipe with the changes made.

Note: the new saved settings will overwrite those of the previous recipe.

Note: to return to the factory settings of the single recipes, you must re-enter and save the settings indicated in the "Beverage type" section.

Coffee grind settings

You can adjust the grind settings using the grinder adjustment knob on the coffee bean container. The ceramic coffee grinder guarantees a perfect and homogeneous grinding for the preparation of every cup of coffee. The aroma is thus preserved, ensuring the perfect flavour every time.

Warning: to avoid damages to the coffee grinder, do not rotate the grinder adjustment knob more than one notch at a time.

- 1 Open the lid of the coffee bean container.
- 2 Press and turn the grinder adjustment knob placed inside the coffee bean hopper one notch at a time. Use the grinder adjustment key. The reference marks in the coffee bean hopper compartment indicate the grinding setting.
- 3 You can select from 5 different grinding settings. The smaller the bar, the stronger and richer the coffee .

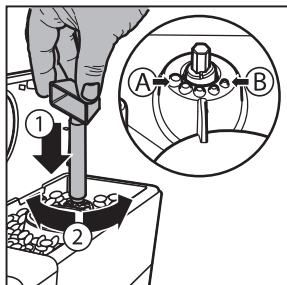

Note:

- Coarse grind: lighter taste, for dark roasted coffee blends (3-5);
- Fine grind: stronger taste, for light roasted coffee blends (1-3);

Cleaning and maintenance

Regular cleaning and maintenance keep the machine in perfect condition and ensure perfect coffee flavour, a constant coffee flow and an excellent milk froth. Please refer to the following table to know when and how to clean the removable parts of the machine. Please read the specific chapter for further information.

Cleaning table

Part description	When to clean	How to clean
Classic pannarello	After use	Remove the classic pannarello and rinse it under running water.
	Weekly	Disassemble the classic pannarello and the rubber handle. Clean them under running water.
Steam wand	After use	Clean the steam wand with a damp cloth. To clean it more thoroughly, you can unscrew the nozzle and wash it with running water.
Brew group	Weekly	Remove the brew group and clean it under running water.
	Depending on usage	See the "Cleaning and lubricating the brew group" chapter.
	Monthly	Clean the brew group with the Gaggia coffee oil remover to remove any oily coffee residue
Drip tray full	When the red mark appears from the drip tray grid.	Empty the drip tray and clean it under running water.
Coffee pucks container	Whenever the machine requires it	Empty the coffee pucks container and clean it under running water. Ensure that the machine is switched on during this procedure, otherwise the coffee pucks container will not reset.
Water tank	Weekly	Clean it under running water.
Pre-ground coffee compartment/coffee outlet duct	Weekly	Clean the upper part using the handle of a spoon, as shown below.

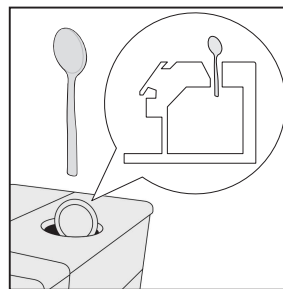



Part description	When to clean	How to clean
------------------	---------------	--------------

Espresso tray	Depending on usage	Remove the espresso tray and clean it with running water. You can also dishwasher it in the upper tray.
---------------	--------------------	---

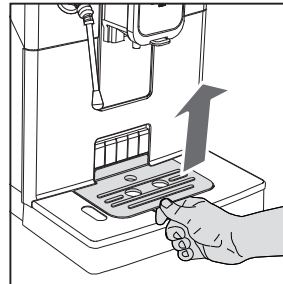

Cleaning the steam system

Cleaning the classic pannarello

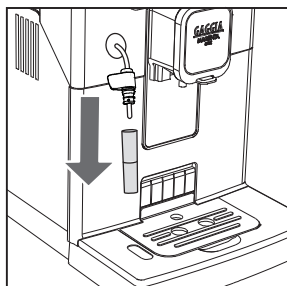

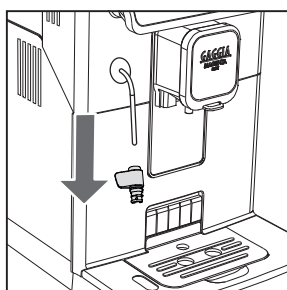

- 1 Remove the classic pannarello and the rubber handle from the steam tube and rinse them under running water.



- 2 Clean the steam tube with a damp cloth.
- 3 Reassemble the parts.

Cleaning the steam wand

- 1 Clean the steam wand with a damp cloth. To clean it more thoroughly, you can unscrew the nozzle and wash it with running water.
- 2 Press the **HOME**  button. Select "STEAM" and press the **START/STOP**  button.
Allowing the steam to escape for one or two seconds to clean the nozzle hole.



Cleaning the brew group

Warning: do not wash the brew group in the dishwasher and do not use dishwashing detergents, since they may cause the malfunctioning of the brew group and alter the coffee flavour.

Removing the brew group

- 1 Turn off the machine and disconnect the power cord.
- 2 Remove the drip tray and the coffee pucks container.
- 3 Open the service door.
- 4 Press the PUSH lever (1) and pull the handle of the brew group (2) to remove it from the machine.

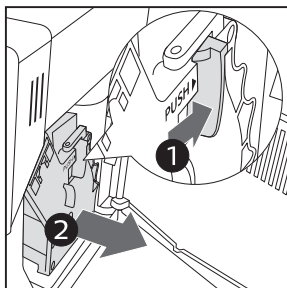

- 5 Remove the coffee residues drawer.

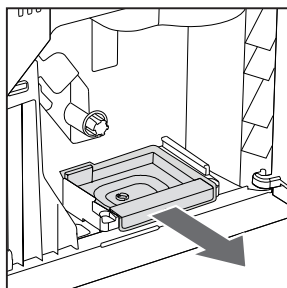

Cleaning the brew group under running water

- 1 Clean the coffee outlet duct thoroughly with a spoon handle or with another round-tipped kitchen utensil.

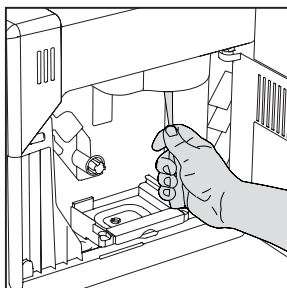

- 2 Rinse the brew group and the coffee residues drawer thoroughly with lukewarm water. Carefully wash the upper filter.
- 3 Let the brew group air dry.

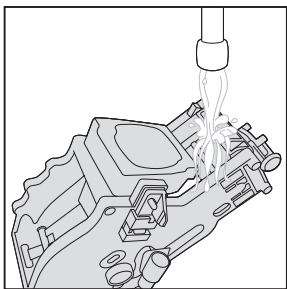

Note: to avoid the build-up of fibres in its interior, do not dry the brew group with cloth.

Reinserting the brew group

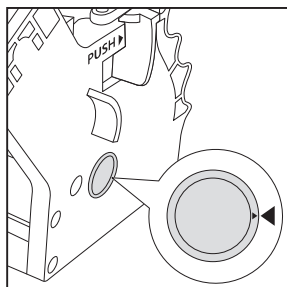

- 1 Before placing the brew group back into the machine, make sure that the two yellow reference marks on the side match. If this is not the case, perform the following step:

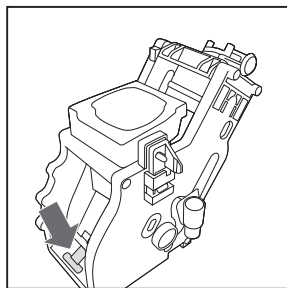

Make sure that the lever is in contact with the base of the brew group.

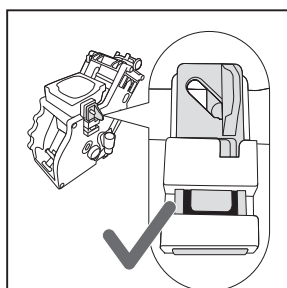

- 2 Make sure that the yellow locking hook of the brew group is in the right position.

To position the hook correctly, push it upwards to the highest possible position.

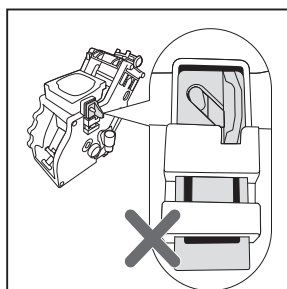

If the hook is still in the lower position, it means that it is not positioned correctly.

- 3 Reinsert the coffee residues drawer.
- 4 Reinsert the brew group into the machine along the side guides until it locks in the right position with a click.



Warning: do not press the PUSH lever.

- 5 Close the service door.

Cleaning the brew group with cleaning tablets for the removal of oily coffee residues



Warning: use only Gaggia cleaning tablets to remove oily coffee residues.

- 1 Place a container under the coffee dispensing spout.
- 2 Press the **CLEAN/SET**  button and select the "CLEAN" button shown on the display.
- 3 Select "BREW GROUP CLEANING" and press the "✓" button, then press **START/STOP**  to start the cleaning procedure.
- 4 Follow the instructions shown on the display to clean the brew group correctly.
- 5 The procedure will take approximately 5 minutes. **START/STOP**  can be used to pause and resume the procedure.

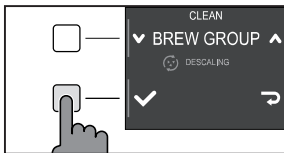

Lubricating the brew group

In order to ensure the perfect performance of the machine, it is necessary to lubricate the brew group. Refer to the following table for the frequency of lubrication.

Frequency of use	Number of beverages prepared daily	Lubrication frequency
Low	1-5	Every 4 months
Regular	6-10	Every 2 months
High	>10	Every month

- 1 Turn off the appliance and disconnect the power cord.
- 2 Remove the brew group and rinse it using lukewarm water - see the "Cleaning the brew group under running water" chapter.
- 3 Apply a thin layer of the lubricant provided around the insertion pin on the lower part of the brew group.

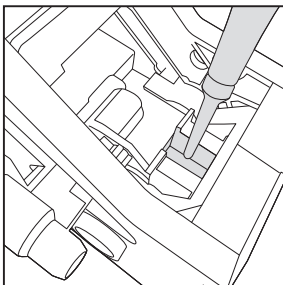

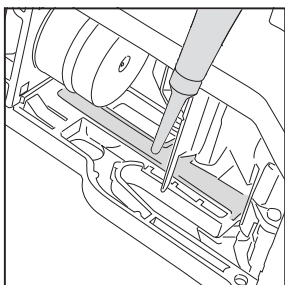
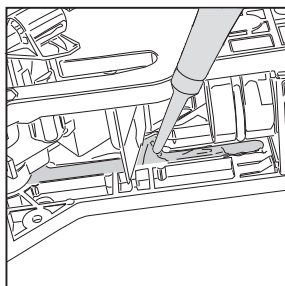

- 4 Apply a thin layer of lubricant to the guides, on both sides (see figure).
- 5 Reinsert the brew group - see the "Reinserting the brew group" chapter.

Note: you can use the lubricant tube multiple times.



Descaling

Descaling procedure

Descaling needs to be carried out when the machine requires it.

Use only Gaggia descaling solution designed to guarantee the machine's excellent performance. The use of different products could damage the machine and leave residue in the water. Failure to descale the machine will void the warranty.



- 1 If present remove the classic pannarello.
- 2 Press **CLEAN/SET**   and select the "CLEAN" button shown on the display.
 - Select "DESCALING" and after confirming with "✓" press the **START/STOP**  button to start.
- 3 Remove the drip tray and the coffee pucks container, empty and place them all back into the machine.
- 4 Remove the water tank and empty it. Remove the INTENZA+ filter, if in place.

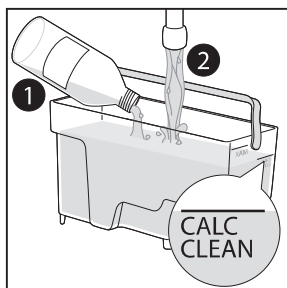

- 5 Pour the entire bottle of Gaggia descaling solution into the water tank and fill the tank with water up to the CALC CLEAN level. Reinsert it into the machine.

- 6 Place a large recipient (1.5l) under the steam tube and the coffee dispensing spout.
- 7 Follow the instructions shown on the display to launch the descaling procedure. This procedure lasts approximately 25 minutes and consists of a descaling cycle and a rinse cycle, carried out with dispensing at regular intervals.
- 8 Once the descaling cycle is complete, rinse the water circuit and tank by following the instructions shown on the display.
- 9 Position the INTENZA+ filter back into the water tank.

Note: it is possible to pause and resume the procedure at any time by pressing the **START/STOP** ►□ button.

Warning: when the descaling procedure is active, the brew group cannot be removed. Wait for the descaling process to end, then remove the brew group.

What to do if the descaling process is interrupted

You can exit the descaling procedure by keeping the **ON/OFF** ⏻ button on the control panel, pressed for a few seconds. If the descaling procedure is interrupted before its completion, proceed as follows:

- 1 Empty the water tank and wash it thoroughly.
- 2 Fill the water tank with running water up to the CALC CLEAN level mark, then switch the machine back on. The machine will warm up and perform an automatic rinse cycle.
- 3 Before preparing any beverages, carry out a manual rinse cycle as described in the dedicated chapter.

Note: if the procedure has not been completed, it will be necessary to carry out another descaling procedure as soon as possible.

Other settings

By pressing the **CLEAN/SET**  button and selecting “SETTINGS” on the display, you can reset or modify some of the machine parameters including:

- Language.
- Water filter.
- Stand-by Time.
- Units.
- Water hardness.
- Beverage counter.
- Button sound
- Factory settings.

Language

When the language setting icon is selected, the list of available languages will be displayed.

Available languages

ITALIAN	DANISH	CZECH
ENGLISH	GREEK	SLOVAK
GERMAN	POLISH	LITHUANIAN
FRENCH	RUSSIAN	JAPANESE
SPANISH	ROMANIAN	KOREAN
PORTUGUESE	HUNGARIAN	CHINESE (TRADITIONAL)
DUTCH	BULGARIAN	CHINESE (SIMPLIFIED)

Water filter

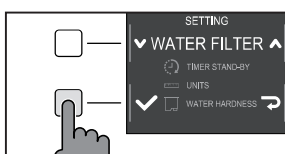

When “WATER FILTER” is selected, follow the instructions on the display and those described under the “Installing the INTENZA+ water filter” and “Replacing the INTENZA+ water filter” chapters.

Stand-by Time

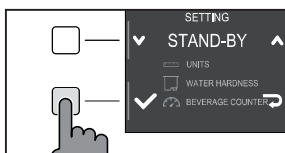

When “STAND-BY TIME” is selected, the timer can be set to:

- 15 min
- 30 min
- 60 min
- 180 min

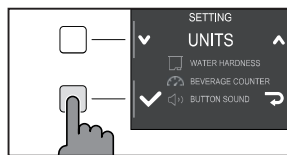

Units

By selecting "UNITS":

you can set the unit of measurement in "ml" or "oz".

Water hardness

With "WATER HARDNESS" selected, follow the instructions on the display and those described under the "Measuring water hardness" chapter.

Beverage counter

It is possible to display the number of cups of each beverage that have been dispensed since the first operation of the machine. These data cannot be reset.

Button sound

You can turn the button sound off by selecting " OFF " so as not to be disturbed.

Factory settings

You can reset the machine to factory default values. The machine will require a double confirmation before proceeding.

Error code key

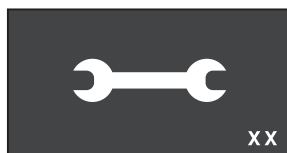

The list below reports the error codes that the display can show, their meanings and how to solve the problem. If the indicated solutions are ineffective because the display continues to show the error code icon and the machine does not return to normal operation, or if other error codes are displayed, you must contact an authorized service center or distributors in your country.

The contact info is listed on www.gaggia.com and www.gaggia.it.







Error code	Problem	Cause	Possible solution
01	The coffee grinder is clogged.	The coffee outlet duct is clogged.	Remove the power cord and remove the brew group. Clean the coffee outlet duct thoroughly using a spoon handle. Switch the appliance back on again.
03 - 04	A problem occurred in the brew group.	The brew group is dirty or not well lubricated.	Switch off the machine. Remove the brew group and clean it thoroughly. (Refer to the "Cleaning the Brew Group" chapter)
		The brew group is not positioned correctly.	Switch off the machine. Remove the brew group and reinsert it. Ensure that the brew group is in the correct position before inserting it. Refer to the "Reinserting the brew group" chapter.
05	A problem occurred in the water circuit.	There is air in the water circuit.	Remove and reinsert the tank in the machine a couple of times. Make sure you insert the tank correctly in the machine. Check that the water tank seat is clean. If you use an "INTENZA+" filter: pull out the filter from the water tank and shake it to remove the air from the filter. Then place the "INTENZA+" filter back into the water tank.
14	The machine is overheated.	There may be multiple causes.	Switch off the machine and switch it back on again after 30 minutes. Perform this operation 2 or 3 times.

Troubleshooting

This chapter outlines the most common problems you may encounter while using the machine. If you are unable to solve the problem using the information provided below, visit the FAQ sections on www.gaggia.com or www.gaggia.it or contact the either the Customer Service Centre or the local distributors in your country.

Problem	Cause	Solution
The machine does not switch on.	The machine is not connected.	Check that the power cord has been inserted correctly.
	The on / off button was not pressed and held down long enough	Keep the on / off button pressed for a few seconds.
The drip tray fills up quickly.	It is a normal phenomenon. The machine uses water to rinse the internal circuit and the brew group. Part of the water flows through the internal system directly into the drip tray.	Empty the drip tray when the red mark appears through the grid. We recommend your placing a cup under the dispensing spout to collect rinse water
The display continuously shows the "coffee pucks container full" icon.	The coffee pucks container has been emptied when the machine was off.	Always empty the coffee pucks container when the machine is on. If you empty the coffee pucks container when the machine is off, the coffee cycle counter does not reset. In this case, the display shows the icon even if the container is not full.
	The coffee pucks container has been placed back too quickly.	Always wait about 5 seconds when you replace the coffee pucks container. This way, the counter will reset to zero.
The machine requests to empty the coffee pucks container even if it is not full.	The machine has not reset the counter last time the coffee pucks container has been emptied.	Always wait about 5 seconds when you replace the coffee pucks container. This way, the coffee grounds counter will reset to zero.
		Always empty the coffee pucks container when the machine is on. If you empty the coffee pucks container when the machine is off, the coffee cycle counter does not reset.
The coffee pucks container is too full and the "coffee pucks container full" icon, did not display.	The drip tray has been removed without emptying the coffee pucks container.	When you remove the drip tray, also empty the coffee pucks container even if it contains only a few coffee pucks. In this way the coffee grounds counter will be reset to zero, re-starting to correctly count the coffee pucks.
Impossible to remove the brew group.	The brew group is not in the correct position.	Close the service door. Switch the machine off and then back on. Wait for the display to show the ready message, then remove the brew group.

Problem	Cause	Solution
The brew group cannot be inserted.	The brew group is not in the correct position.	The brew group has not been positioned correctly before being placed back. Ensure that the lever is in contact with the base of the brew group and that the hook of the brew group is in its correct position. See the "Reinserting the brew group" chapter.
		To reset the machine put the drip tray with the coffee pucks container back in place. Do not insert the brew group. Close the service door, then unplug the power cord and plug it back in. Then try to reinsert the brew group and switch on the machine.
The espresso is not creamy enough or it is watery.	The coffee grinder is set to a coarse grinding.	Adjust the coffee grinder to a finer setting.
	The machine is performing its self-adjustment.	Dispense several cups of coffee so that the machine adjusts itself automatically.
	The coffee outlet duct is clogged.	Clean the coffee outlet duct with a spoon as described in the "Cleaning the brew group under running water" chapter.
The brewed coffee is not hot enough.	The set temperature is too low. Check the menu settings.	Set the menu temperature to "MAX".
The machine grinds the coffee beans, but no brewing happens.	The coffee grinder is set to a too fine grinding.	Adjust the coffee grinder to a coarser grinding.
	The coffee dispensing spout is blocked.	Dispense a long coffee from pre-ground coffee but without actually adding pre-ground coffee.
	The nozzles of the coffee dispensing spout are blocked.	Clean the nozzles of the coffee dispensing spout with a small bottlebrush.
The coffee comes out slowly or in drops.	The coffee grinder is set to a too fine grinding.	Adjust the coffee grinder to a coarser grinding.
	The nozzles of the coffee dispensing spout are blocked.	Clean the nozzles of the coffee dispensing spout with a small bottlebrush.
	The machine circuit is clogged by limescale.	Descale the machine.
The milk does not froth.	The classic pannarello may be dirty. (model with classic pannarello)	Clean the classic pannarello as described in the chapter "Cleaning the classic pannarello".
		Make sure that all the classic pannarello components have been correctly assembled
	The steam wand nozzle is clogged. (model with steam wand)	Wash the steam nozzle with running water and clean the circuit by dispensing a small quantity of hot water
	The type of milk used is not suitable for foaming.	The amount and the quality of froth vary depending on the type of milk.

Problem	Cause	Solution
The "INTENZA+" filter cannot be inserted.	Remove the air from the filter.	Let the air bubbles out of the filter.
	The tank still contains some water.	Empty the water tank before installing the filter.
	The rubber seal is not inserted onto the "INTENZA+" filter.	Check the packaging and insert the seal onto the "INTENZA+" filter.
You can not activate the "INTENZA+" filter.	Another filter is already active	The machine indicates the filter usage in percentage. However, if you want to activate a new filter before the one currently in use has expired, the latter must be disabled first as described in the section "Replacing INTENZA+ water filter"
There is some water under the machine.	The drip tray is too full and has spilled over.	Empty the drip tray when the mark appears though the tray. Always empty the drip tray before starting the descaling procedure.
The machine is in DEMO mode.	While switching on the machine, you pressed a combination of buttons (HOME  - CLEAN/SET   - HOME  - CLEAN/SET  ).	Switch the machine off and on again, with the ON/OFF  button on the control panel.

GAGGIA accessories

Coffee and accessories are available through authorised centres (Italy), or distributors in your country.



Descaling product



INTENZA+ water filter



Coffee oil remover



Coffee range available in beans and powder: 100% Arabica / Intense / Decaffeinated

Technical specifications

Nominal voltage - Power rating - Power supply	See data plate on the inside of the service door
Housing material	Thermoplastic type
Dimensions	224 x 357 x 435 mm
Weight	7,6 kg
Power cord length	1200 mm
Control panel	Front panel
Water tank	1.8 litres - Removable type
Coffee bean container capacity	250 g
Coffee pucks container capacity	15
Pump pressure	15 bar
Boiler	Stainless steel boiler
Safety devices	Thermal Fuse